



FAHRZEUGEINRICHTUNGEN
FITTINGS FOR COMMERCIAL VEHICLES



FIAT DOBLÒ





StoreVan ist weltweit der einzige Hersteller von Nutzfahrzeugeinrichtungen, der mit dieser Technologie arbeitet.

StoreVan is the sole LCV's equipment manufacturer worldwide to make use of this technology.

TECHNOLOGIE

GALVANNEALED STAHL

Galvannealed Blech ist eine Variante von feuerverzinktem Blech. Das Produkt unterliegt einem Feuerbeschichtungsprozess und wird bis ca. 550 °C erhitzt. Dies ermöglicht es dem Zink mit dem Stahlblech eine Legierung einzugehen. Das Ergebnis ist eine Beschichtung mit einer gleichförmigen, feinkörnigen Kristallstruktur an der Beschichtungs Oberfläche und einer **sehr hohen Oberflächenqualität und Korrosionsbeständigkeit**.

Dieses Verfahren ist ideal für Automotive Anwendungen. StoreVan hat diese Technik nun auch im Bereich Nutzfahrzeugeinrichtungen implementiert.

DAS VERFAHREN DER KATHODISCHEN ACRYL-TAUCHLACKIERUNG

Die kathodische Acryl-Beschichtung ist eine Oberflächenbehandlung, die den einzelnen Teilen der Einrichtung eine **extrem hohe Korrosionsbeständigkeit** verleiht. Das Tauchverfahren gewährleistet eine **gleichmäßige Beschichtung** und einen lang anhaltenden Schutz egal gegen welche Stoffe. Das Acrylharz schützt den Lack bei direkter Belichtung durch die Witterung gegen Ausbleichen und gegen Veränderungen der Korrosionsbeständigkeit.

- Korrosionsbeständigkeit von über 500 Stunden (ASTM D1735 Luftfeuchtigkeit)
- Ausgezeichnete Härte mit einem Mindeststrating von 2H



STORE VAN ORANGE PLANET

Nachhaltigkeit und ökologische Entwicklung sind Themen von großem, aktuellem Interesse, entstanden durch das steigende Bewusstsein, dass auf die Umweltbalance aufgrund der zyklischen Veränderungen und Erneuerungen geachtet werden muss.

STORE VAN ORANGE PLANET

Environmental sustainability and eco-compatible development are topics of great interest and relevance, arising from the growing awareness that it is important to pay attention to the environmental balance.

TECHNOLOGIES

GALVANNEALED STEEL

Galvannealed sheet is a variant of hot-dip galvanized sheet. The product is subject to a hot-dip galvanization process and subsequently heated to approximately 550°C, combining the zinc with the sheet surface to make an alloy with iron. The result is a uniform zinc coating with a fine-grained crystalline structure along with a **much higher surface quality and corrosion resistance**. This process is ideal for automotive applications. StoreVan has introduced and implemented this technology in the commercial vehicles equipment field.

CATHODIC DIP PAINTING WITH ACRYLIC RESIN

Cataphoresis painting is a paint surface treatment able to give the equipment elements a **remarkable resistance to corrosion**; characterized by **uniform deposit** of an acrylic resin on the element surface, it ensures long lasting, high protection against chemical agents and other types of surface attacks. The acrylic resin allows a direct exposure to atmospheric agents without altering its technical features. This process ensures an increased protection against rust.

- Corrosion resistance of more than 500 hours (humidity ASTM D1735)
- Excellent hardness with a minimum rating of 2H



FLEXIBLES BEFESTIGUNGSSYSTEM

FLEXIBLE FIXING SYSTEM

DIE FLEXIBILITÄT UND DAUERHAFTIGKEIT DER STORE VAN TRANSPORTEREINRICHTUNGEN

Store Van benutzt zur Befestigung der Transporterregale am Fahrgestell des Nutzfahrzeuges ein spezielles Schienensystem und sorgt damit für eine besonders flexible Positionierbarkeit der Module und eine maximale Nutzung der Innenräume des ausgestatteten Transporters.

Bei diesem System werden Bügel benutzt, die in der Gesamtlänge der Schiene gleiten, anstatt direkt an den Verstärkungen des Fahrgestells angenietet zu sein, was beim Entwurf der Transportereinrichtung grundsätzlich zu einer starren Raumnutzung zwingt. Die von Store Van verwendete Schiene wird an die vertikalen Pfosten der mobilen Werkstatt befestigt und hat die doppelte Funktion einer gleichmäßigen Verbindung der Transporterregale am Fahrzeugrahmen und einer homogenen Verteilung aller dynamischen Kräfte, denen die Einrichtung während der Fahrt ausgesetzt ist.

Die Befestigungsbügel für die Verbindung der Schiene am Modul besitzen ein spezielles Gelenk, das die bei der Fahrt verursachten Vibrationen dämpft, indem es sich den Torsionsbewegungen des Fahrgestells anpasst, vor allem beim Kurvenfahren.

Dieses System bietet beim Entwurf unserer Transportereinrichtungen eine erhebliche Gestaltungsfreiheit, wobei in jedem Fall hohe Sicherheits-, Stabilitäts- und Dauerhaftigkeitsstandards garantiert werden.

Bei allen unseren Befestigungssystemen können für die Module Schnellankupplungs- und -loskupplungssysteme mit Feststellgriffen eingesetzt werden, die eine werkzeuglose Demontage der Einrichtung ermöglichen. Dadurch kann das Regal Ihrer mobilen Werkstatt, wie in der RICHTLINIE 2014/47 EU, KAP. 1, Artikel 3, Absatz 5 beschrieben, als transportiertes Material oder als Hilfsmittel für die Sicherheit der nicht dauerhaft am Fahrzeug befestigten Ladung erklärt werden.

FLEXIBILITY AND DURABILITY OF STORE VAN EQUIPMENT

Store Van uses a special rail anchoring system to secure shelving units for vans to the chassis of your vehicle, improving the flexibility of module arrangement and maximising the internal spaces of your van.

This system is based on brackets sliding all along the rail rather than being riveted to chassis reinforcements, thus offering great flexibility in the management of internal spaces. The Store Van rail is secured to the uprights of your mobile workshop and has a two-fold function: it connects shelving units uniformly to the frame of your vehicle, and it evenly distributes all the dynamic forces your van equipment is subject to while travelling. Special vibration damping joints, fitted on the brackets connecting the rail to the module, absorb the torsional vibration applied on the chassis especially when driving on a curve.

Thanks to this system, our fittings for vans can be designed with maximum freedom, always ensuring high safety, stability and durability standards.

Our anchoring systems are fitted with quick locking/unlocking devices with adjustable handles, so users can remove the fittings with no need of tools. Hence the shelving units of your mobile workshop may be considered as transported goods or load securing fittings not permanently fixed to the vehicle, in compliance with Directive 2014/47EU, Chapter 1, Article 3, Item 5.



ZERTIFIZIERUNGEN CERTIFICATIONS

ZERTIFIZIERTE PRODUKTION

- Nach ISO 9001:2015 zertifiziert.
- Erfolgreicher CRASH TEST durchgeführt nach ECE-R17 mit einer Aufprallgeschwindigkeit von 50 Km/h.
- GS-Zertifizierung für Inneneinrichtungen und Laderampen.
- GS-Zertifizierung für Dachträger und Leiterträger.

CERTIFIED PRODUCTION

- ISO 9001:2015 certified.
- Brilliantly passed the CRASH TEST carried out according to the most recent European regulations ECE-R17 with impact at 50 Km/h.
- GS certification for interior fittings and loading ramps.
- GS certification for roof and ladder racks.

CRASH TEST
ECE-R17



Grundlage für den sicheren Schutz von Fahrzeugen

Base for the safe protection of vehicles



LADUNGSSICHERUNG FÜR TRANSPORTER UND SICHERE BEFESTIGUNG DER WAREN

Durch die Umsetzung der Richtlinie 2014/47/EU wird eine Intensivierung der Kontrollen an Kraftfahrzeugen für die Güterbeförderung der Klassen N2 und N3 und eine aufmerksamere Kontrolle der Ladungssicherung erfolgen. Die Richtlinie ermöglicht es den Mitgliedsstaaten, Fahrzeuge, die über den Anwendungsbereich hinausgehen, wie z.B. Nutzfahrzeuge der Klasse N1, technischen Kontrollen zu unterziehen, sowie weitere Aspekte des Transports und der Straßenverkehrssicherheit zu kontrollieren.

SCHUTZSYSTEM DES LADERAUMS UND LADUNGSSICHERUNG

Das neue integrierte Transporter-Schutzsystem von Store Van folgt den Leitlinien der neuen Richtlinie 2014/47/EU und erlaubt eine **flexible und sichere Befestigung** der Ladung an den Ladeflächen und Innenwänden des Fahrzeugs.

Mit den „Airline“ Festhaltekomponenten und dem Einbau zahlreicher Zubehörteile wie Riemen, Netze und teleskopische Spannstangen kann der Fahrzeugbenutzer seine Festhalteplattform einfach, ergonomisch und in Entsprechung der europäischen Richtlinien gestalten.

Das System umfasst die folgenden Bestandteile:

- Mehrschichtige Bodenplatten für Transporter mit Phenolharzverleimung, mit eingelassenen Aufnahmen für die Originalverankerungen des Fahrzeugs und mit zusätzlichen bodenplattenflächigen Verankerungen (S. 10) mit einer Zugkraft von 200 daN;
- am Fahrgestell verankerte „Airline“ Aluminiumschienen (S. 11);
- hochflexible und hochresistente Polypropylenpaneele für den internen Schutz der Karosserie vor Stößen (S. 8).

DAS ANBRINGEN DES NEUEN SCHUTZSETS SORGT FÜR EINE LANGE REIHE VON VORTEILEN:

- Der Fahrzeugbenutzer kann die Ladung schon mit den Zurrgurten sicher an den „Airline“ Schienen befestigen.
- Das integrierte Befestigungsset hält die Karosserie länger in gutem Zustand.
- Das Schutzsystem verleiht einen Mehrwert, der schon auf dem Markt der Neufahrzeuge sehr wichtig erscheint und bei Gebrauchtfahrzeugen, die normalerweise Karosserieschäden aufweisen, sogar von grundlegender Bedeutung ist.



VAN LOAD SECURING AND CARGO RESTRAINT

Transposition of directive 2014/47/EU will intensify control of N2 and N3 category transport vehicles and cargo securement enforcement. Under this Directive, the Member States can subject vehicles that are beyond the scope of the Directive, such as N1 category vehicles, to technical inspections, and also monitor other transport and road safety aspects.

CARGO AREA PROTECTION SYSTEM AND CARGO RESTRAINT

The new Store Van integrated system for van protection follows the guidelines of Directive 2014/47/EU while making the **anchoring of the cargo to the van floor and walls flexible and safe.**

With the use of „Airline“ securing components and integration of many different accessories such as belts, nets and telescopic load restraining bars, final users may configure their cargo platform easily and cheaply and in conformity with the European Directive.

The system uses:

- phenolic resin plywood floor panels, arranged to fit original anchoring fittings and additional 200 daN strength lashing points (page 10), flush with the floor panel;
- aluminium „Airline“ bars anchored to the chassis (page 11);
- highly flexible and resistant polypropylene panelling to protect the internal body shell from accidental impacts (page 8).

THE NEW LOAD SECURING SYSTEM OFFERS NUMEROUS ADVANTAGES:

- users can safely secure the load to the „Airline“ bars with load restraining belts;
- the integrated load securing system extends the body's good condition over the time;
- the protection system offers new added value, an important economic aspect for a new vehicle and a fundamental characteristic for a second-hand vehicle, that is usually exposed to damage.

SAFETY CROSS: Fixierpunkte in Längs- und Querrichtung nach Anfrage.
SAFETY CROSS: longitudinal and transversal fixing points upon request.

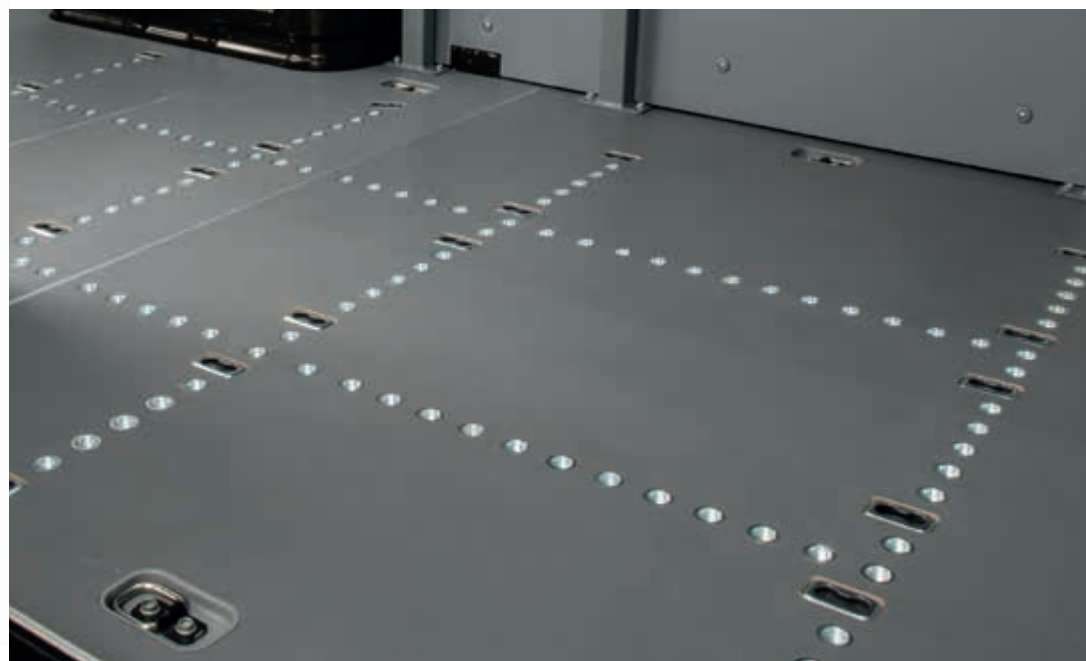



- Seitenverkleidungen für Fahrzeug mit rechter Schiebetür und Seitenwänden aus Vollblech.
- Linings for right side door vehicle with metal sheet sidewalls.



HONEYCOMB PANEL - A

- Seitenverkleidung aus Polypropylen für:
 - linke Seitenwand
 - rechte Seitenwand und Schiebetür
- Polypropylene linings for:
 - LH sidewall
 - RH sidewall and sliding door

HONEYCOMB PANEL - C

- Seitenverkleidung aus Polypropylen für:
 - oberen Teil der Heckflügeltüren
- Polypropylene linings for:
 - upper part of rear hinged doors



FAHRZEUG VEHICLE	SEITENVERKLEIDUNG LINING	
	A ART.	C ART.
Fahrzeugtyp - Model L1 H1	F22 HP D010H1 A0 01 3,11 kg	F22 HP D0DRH1 A0 01 1,20 kg
Fahrzeugtyp - Model L1 H2	F22 HP D010H1 A0 01 3,11 kg	F22 HP D0DRH2 A0 01 1,61 kg
Fahrzeugtyp - Model L2 H1	F22 HP D020H1 A0 01 4,63 kg	F22 HP D0DRH1 A0 01 1,20 kg
Fahrzeugtyp - Model L2 H2	F22 HP D020H1 A0 01 4,63 kg	F22 HP D0DRH2 A0 01 1,61 kg

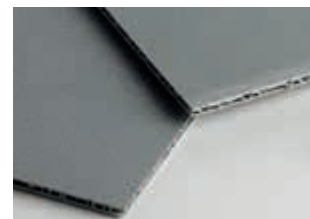

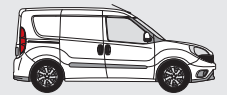

- Bodenplatte für Fahrzeug mit rechter Schiebetür und Seitenwänden aus Vollblech.
- Flooring for right side door vehicle with metal sheet sidewalls.



WOOD FLOOR - D

- Bodenplatte aus Multiplex mit Phenolbeschichtung, Stärke 9 mm, für das Originalverankerungssystem des Fahrzeugs vorgebohrt.
- 9 mm thick wooden flooring with phenolic coating set for the vehicle original anchoring system

WOOD FLOOR - F

- Kabinenrückwandplatte aus Multiplex mit Phenolbeschichtung, Stärke 12 mm
- 12 mm thick wooden bulkhead panel with phenolic coating

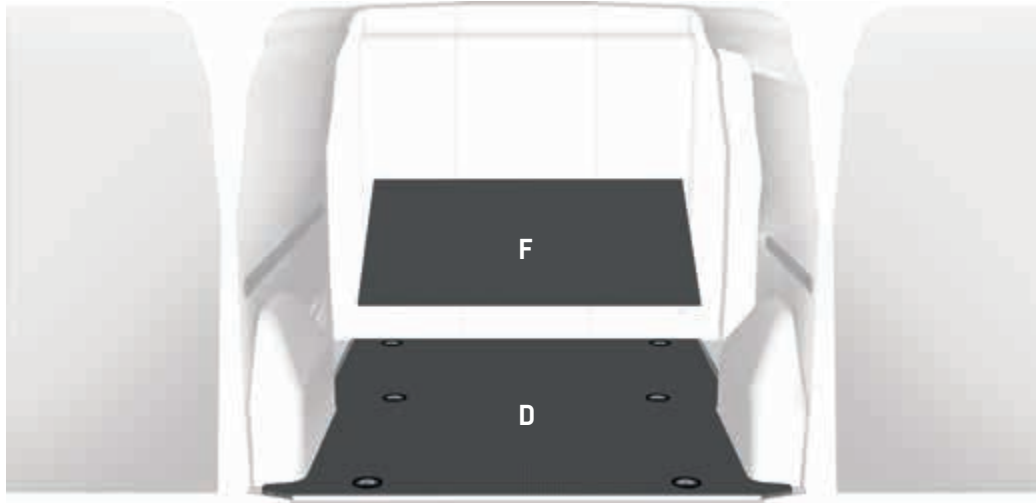

FAHRZEUG VEHICLE	BODENPLATTE 9 mm 9 mm FLOORING	RÜCKWANDPLATTE BULKHEAD
	D	F (1275x430x12 mm)
	ART.	ART.
Fahrzeugtyp - Model L1 ^A	F22 WF D010D1 B0 1S 14,70 kg	F22 WF DOWBT1 B0 1S 4,24 kg
Fahrzeugtyp - Model L1 ^B	F22 WF D010D2 B0 1S 14,50 kg	
Fahrzeugtyp - Model L2 ^A	F22 WF D020D1 B0 1S 17,70 kg	F22 WF DOWBT1 B0 1S 4,24 kg
Fahrzeugtyp - Model L2 ^B	F22 WF D020D2 B0 1S 17,47 kg	



^A Kabinenrückwand aus Vollblech - Steel bulkhead
^B Kabinenrückwand aus Gitter mit Tür - Hinged Mesh Bulkhead



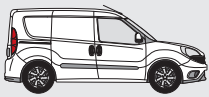

- Bodenplatte für Fahrzeug mit rechter Schiebetür und Seitenwänden aus Vollblech.
- Flooring for right side door vehicle with metal sheet sidewalls.



SAFETY FLOOR - D

- Bodenplatte 9 mm aus phenolbeschichtetem Holz mit zusätzlichem Einzelzurrpunktensystem.

- 9 mm phenol faced plywood flooring with additional lashing points

WOOD FLOOR - F

- Kabinenrückwandplatte aus Multiplex mit Phenolbeschichtung, Stärke 12 mm

- 12 mm thick wooden bulkhead panel with phenolic coating

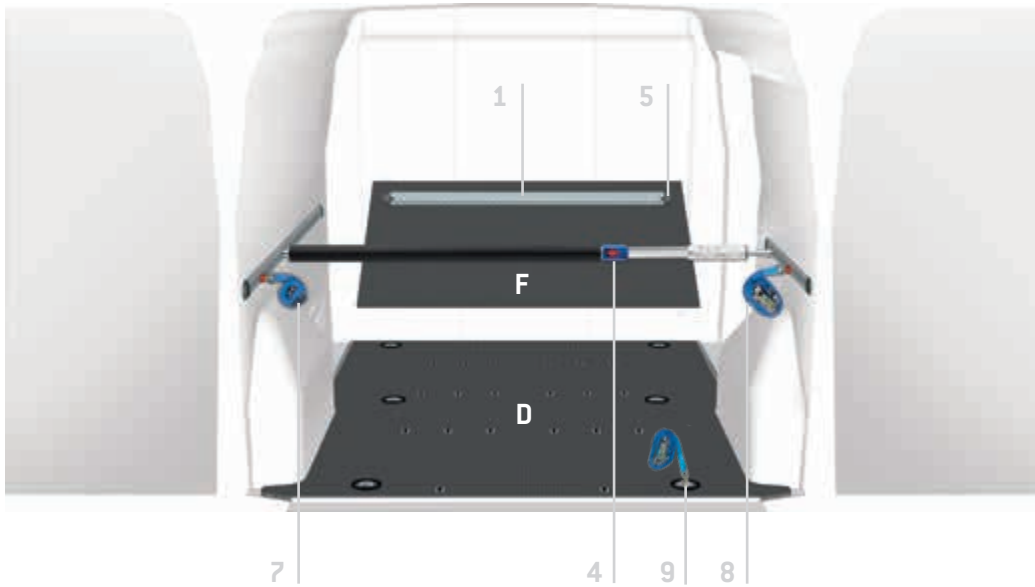

FAHRZEUG VEHICLE	BODENPLATTE 9 mm FLOORING 9 mm	RÜCKWANDPLATTE BULKHEAD
	D	F (1275x430x12 mm)
	ART.	ART.
Fahrzeugtyp - Model L1 ^A	F22 SF D010K1 B0 1S 16,61 kg	F22 WF DOWBT1 B0 1S 4,24 kg
Fahrzeugtyp - Model L1 ^B	F22 SF D010K2 B0 1S 16,40 kg	
Fahrzeugtyp - Model L2 ^A	F22 SF D020K1 B0 1S 20,16 kg	F22 WF DOWBT1 B0 1S 4,24 kg
Fahrzeugtyp - Model L2 ^B	F22 SF D020K2 B0 1S 19,95 kg	

^A Kabinenrückwand aus Vollblech - Steel bulkhead

^B Kabinenrückwand aus Gitter mit Tür - Hinged Mesh Bulkhead

⚠ Die Bodenplatte muss auf den Fahrzeugboden aufgeklebt sein.
The floor must be glued to the vehicle



- Silikonklebstoff für Bodenplatten.
- Silicone glue for flooring.

ART.

F22 VT V22585 00 08

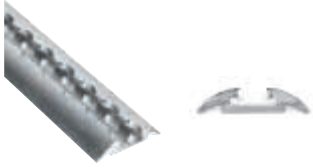
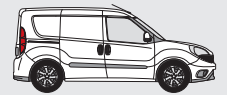

1

- Horizontale Aluschiene.
- Horizontal aluminium bar.

ART. **F22 FC V18029 05 00** L. 500 mm
F22 FC V18029 10 00 L. 1000 mm
F22 FC V18029 15 00 L. 1500 mm
F22 FC V18029 20 00 L. 2000 mm
F22 FC V18029 25 00 L. 2500 mm

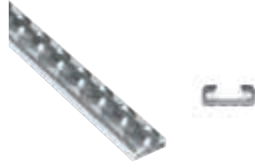

2

- Horizontale Aluschiene.
- Horizontal aluminium bar.

ART. **F22 FC V18025 05 00** L. 500 mm
F22 FC V18025 10 00 L. 1000 mm
F22 FC V18025 15 00 L. 1500 mm
F22 FC V18025 20 00 L. 2000 mm



5

- Endstück aus Kunststoff für Aluschiene Serie V18029.
- Plastic end cap for bar series V18029.

ART. **F22 FC V22106 00 00**



10

- Endstück aus Kunststoff für Aluschiene Serie V18025.
- Plastic end cap for bar series V18025.

ART. **F22 FCV23389 00 00**

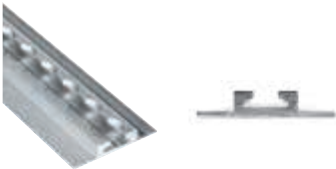

3

- Horizontale Aluschiene.
- Horizontal aluminium bar.

ART. **F22 FC V18030 10 00** L. 1000 mm
F22 FC V18030 15 00 L. 1500 mm
F22 FC V18030 20 00 L. 2000 mm
F22 FC V18030 25 00 L. 2500 mm
F22 FC V18030 30 00 L. 3000 mm



4

- Teleskopische Spannstange.
- Telescopic load restraining bar.

ART. **F22 FC V22149 00 00** L. 650-900 mm
F22 FC V22734 00 00 L. 850-1100 mm
F22 FC V22735 00 00 L. 1050-1300 mm
F22 FC V22131 00 00 L. 1250-1750 mm
F22 FC V22017 00 00 L. 1550-2050 mm
F22 FC V22086 00 00 L. 2000-2500 mm



- Beispiel von Ladungssicherungskoffer-kit.
- Example of tool case for load securing.



6

- Zurring.
- Ring stud fitting.

ART. **F22 FC V22582 00 00**



7

- Zurring mit Hebelspannschloss 2500+500.
- Load restraining belt with clamp 2500+500.

ART. **F22 FC V22136 00 00**



F22 SB BOX080 00 01
1 ART.
 B=440 T=350 H=80 mm
 W=440 D=350 H=80 mm



F22 SB CPV080 00 01
1 ART.



F22 SB YELLOW 63 05
1 ART. YELLOW



F22 FC V22582 00 00
4 ART.



F22 FC V22136 00 00
2 ART.



8

- Zurring mit Ratschenschloss 2500+500.
- Load restraining belt with ratchet 2500+500.

ART. **F22 FC V22124 00 00**



9

- Zurring mit Ratschenschloss 4500+500.
- Load restraining belt with ratchet 4500+500.

ART. **F22 FC V22148 00 00**



F22 FC V22124 00 00
2 ART.



F22 FC V22148 00 00
2 ART.

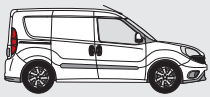

BESTANDTEILELISTE SEITENWANDVERKLEIDUNGEN - LININGS LEGEND

FIAT DOBLÒ
KASTENWAGEN - PANEL VAN

HP
HONEYCOMB
PANEL

- Für Fahrzeug mit rechter Schiebetür und Seitenwänden aus Vollblech.
- For right side door vehicle with metal sheet sidewalls.

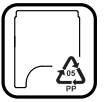

Fahrzeugtyp - Model
L1 H1

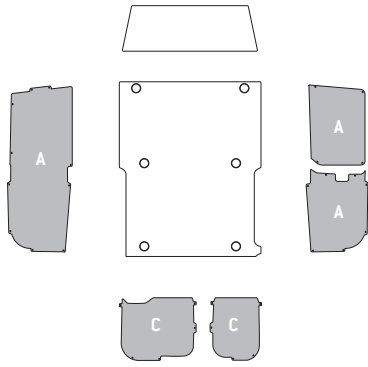

Fahrzeugtyp - Model
L1 H2

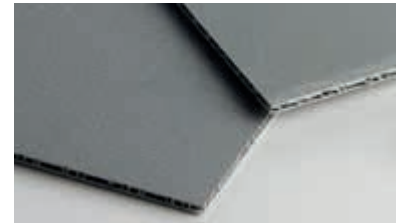
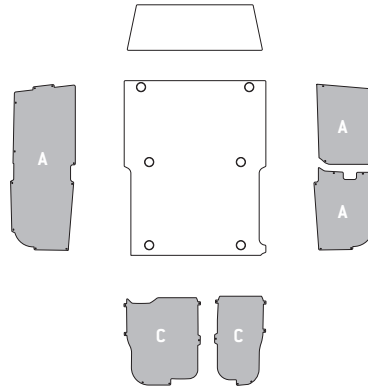

Fahrzeugtyp - Model
L2 H1

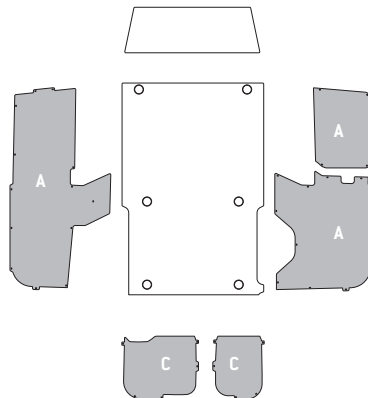

Fahrzeugtyp - Model
L2 H2

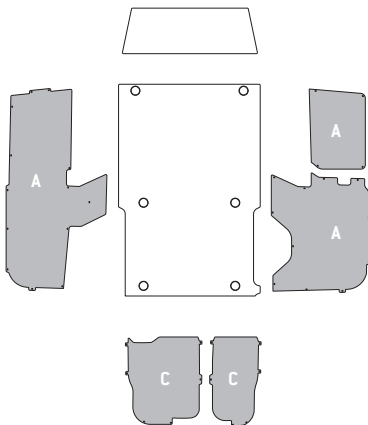

SAFETY CROSS: Fixierpunkte in Längs- und Querrichtung nach Anfrage.
SAFETY CROSS: longitudinal and transversal fixing points upon request.

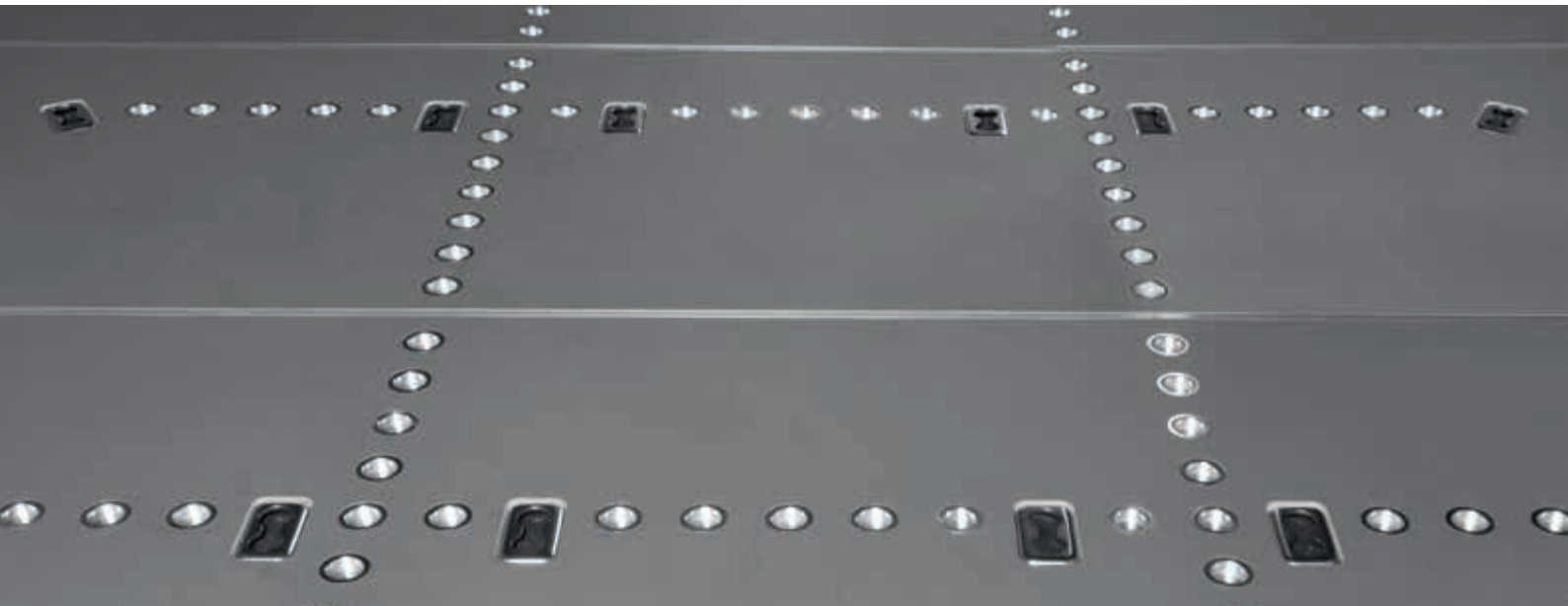

BESTANDTEILELISTE BODENPLATTE - FLOORING LEGEND



- Für Fahrzeug mit rechter Schiebetür und Seitenwänden aus Vollblech.
- For right side door vehicle with metal sheet sidewalls.

Fahrzeugtyp - Model L1 ^A	Fahrzeugtyp - Model L1 ^B	Fahrzeugtyp - Model L2 ^A	Fahrzeugtyp - Model L2 ^B

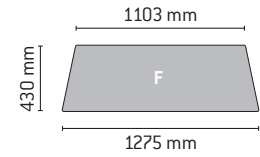

- Kabinenrückwandplatte.
- Bulkhead panel

- ^A Kabinenrückwand aus Vollblech - Steel bulkhead
- ^B Kabinenrückwand aus Gitter mit Tür - Hinged Mesh Bulkhead

KASTENWAGEN - PANEL VAN
FIAT DOBLÒ

WOOD
FLOOR
WF

- Für Fahrzeug mit rechter Schiebetür und Seitenwänden aus Vollblech.
- For right side door vehicle with metal sheet sidewalls.

Fahrzeugtyp - Model L1 ^A	Fahrzeugtyp - Model L1 ^B	Fahrzeugtyp - Model L2 ^A	Fahrzeugtyp - Model L2 ^B



- Jede Reihe von Verankerungspunkten für jede Bodenplatte besteht aus 4/6 "Airline" Einzelzurrpunkten.
- In each flooring, each lashing row is composed of 4/6 "Airline" lashing points.

- ^A Kabinenrückwand aus Vollblech - Steel bulkhead
- ^B Kabinenrückwand aus Gitter mit Tür - Hinged Mesh Bulkhead

SAFETY
FLOOR
SF



SAFETY



**Serienmäßig mit
Ladungssicherung**

**Factory-fitted load
securing**

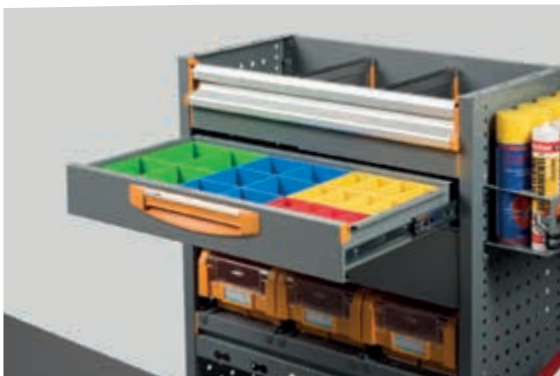

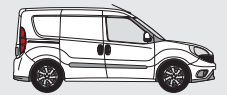

Die Lösungen der **SAFETY Transportereinrichtungen** von Store Van erfüllen die Erfordernisse der neuen Ladungssicherungsbestimmungen. In die Module werden Strukturelemente eingebaut, die eine Nutzung der „Airline“ Festhaltesysteme wie Gurte, Netze und teleskopische Spannstangen erlauben. Dieses neue Niveau der **Einrichtungen für Nutzfahrzeuge** erleichtert das Verankern von mittelgroßen und kleinen Gegenständen, selbst wenn die Transporter-Bodenplatten nicht mit Verankerungssystemen ausgestattet sind, und garantiert dadurch die Ladungssicherung. Die „Airline“ Verankerungselemente des SAFETY-Niveaus erhöhen die Stabilität der Module ohne Gewichtszunahme, denn sie in der Struktur der Einrichtung integriert sind.

The Store Van **SAFETY equipment solution** meets the requirements of the new cargo restraint regulations. Our modules are integrated with structural elements where “Airline” anchoring fittings, such as belts, nets and telescopic bars can easily fit. This new equipment for commercial vehicles simplifies the securing of medium-sized or small parts, even if the floor panel of your van has no anchoring systems, to guarantee maximum load securing. The “Airline” anchoring fittings for SAFETY equipment improve the stability of modules with no weight increase, because they are built in the equipment structure.



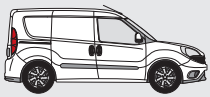

PROFESSIONAL

**Die perfekte Integration
zwischen Fahrzeug und mobiler
Werkstatteinrichtung**

**Perfect integration between
vehicle and mobile workshop
equipment**



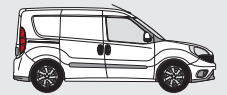

Die Transportereinrichtung **PROFESSIONAL** von Store Van ist perfekt im Fahrzeug integriert und eigens so entwickelt, dass sie die strukturellen und dynamischen Eigenschaften des Fahrzeugs hervorhebt. In den Modulen dieses neuen **Einrichtungsniveaus für Nutzfahrzeug**, z.B. in den Regalen für Transporter, sind für eine perfekte Befestigung der Ladung am Fahrzeugrahmen serienmäßig Elemente eingebaut, die „Airline“ Festhaltesysteme nutzen. Dank der neuen Bodenplatte **SAFETY FLOOR** stehen für die Ladungen vertikale und horizontale Festhaltesysteme zur Verfügung.

The Store Van **PROFESSIONAL equipment solution** is perfectly integrated in your vehicle and has been designed to enhance its structural and dynamic characteristics. The modules of this new **equipment for commercial vehicles**, such as shelving units for vans, are factory fitted with elements ensuring a perfect load anchoring to the chassis of your vehicle with “Airline” anchoring systems.

Both vertical and horizontal load restraining elements can be installed in your van thanks to the new **SAFETY FLOOR** panel.



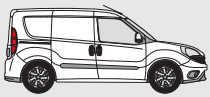

MOBILE

**Nicht nur Fahrzeug,
sondern auch Mobilität**

All-out mobility





Die Lösung MOBILE ergänzt die Store Van Nutzfahrzeugeinrichtungen mit den Kleinteilekoffern der Serie STORE BOX 102 – 136 – 238 und dem dazugehörigen Wagen, der den Benutzer der **mobilen Werkstatt** beim Transport der Waren und Ausrüstung vom Fahrzeug zur Arbeitsstelle unterstützt. Die neuen „Airline“ Verankerungselemente erhöhen die Stabilität des Moduls, ohne sein Gewicht zu beeinflussen. Auch in diesem Fall werden in den Regalen Elemente eingebaut, die eine Nutzung der „Airline“ Festhaltesysteme ermöglichen. Auch dank der Einführung der Bodenplatte SAFETY FLOOR können sowohl vertikale als auch horizontale Ladungssicherungssysteme gewählt werden.

The **MOBILE equipment solution** integrates Store Van fittings for commercial vehicles with small-parts cases, series STORE BOX 102 – 136 – 238, and trolleys by which **mobile workshop** users can easily carry their goods and tools from their van to the workplace.

The new “Airline” anchoring fittings improve the stability of modules with no weight increase. Here shelving units are integrated with elements where “Airline” anchoring systems can easily fit. Both vertical and horizontal load restraining elements can be installed in your van thanks to the new SAFETY FLOOR flooring panels.



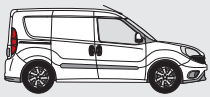

FLOOR UP

Die ergonomische Einrichtung, die sichere Arbeitsbedingungen erleichtert.

Ergonomic equipment that makes work easier and safer

FIAT DOBLÒ
KASTENWAGEN - PANEL VAN

FLOOR UP

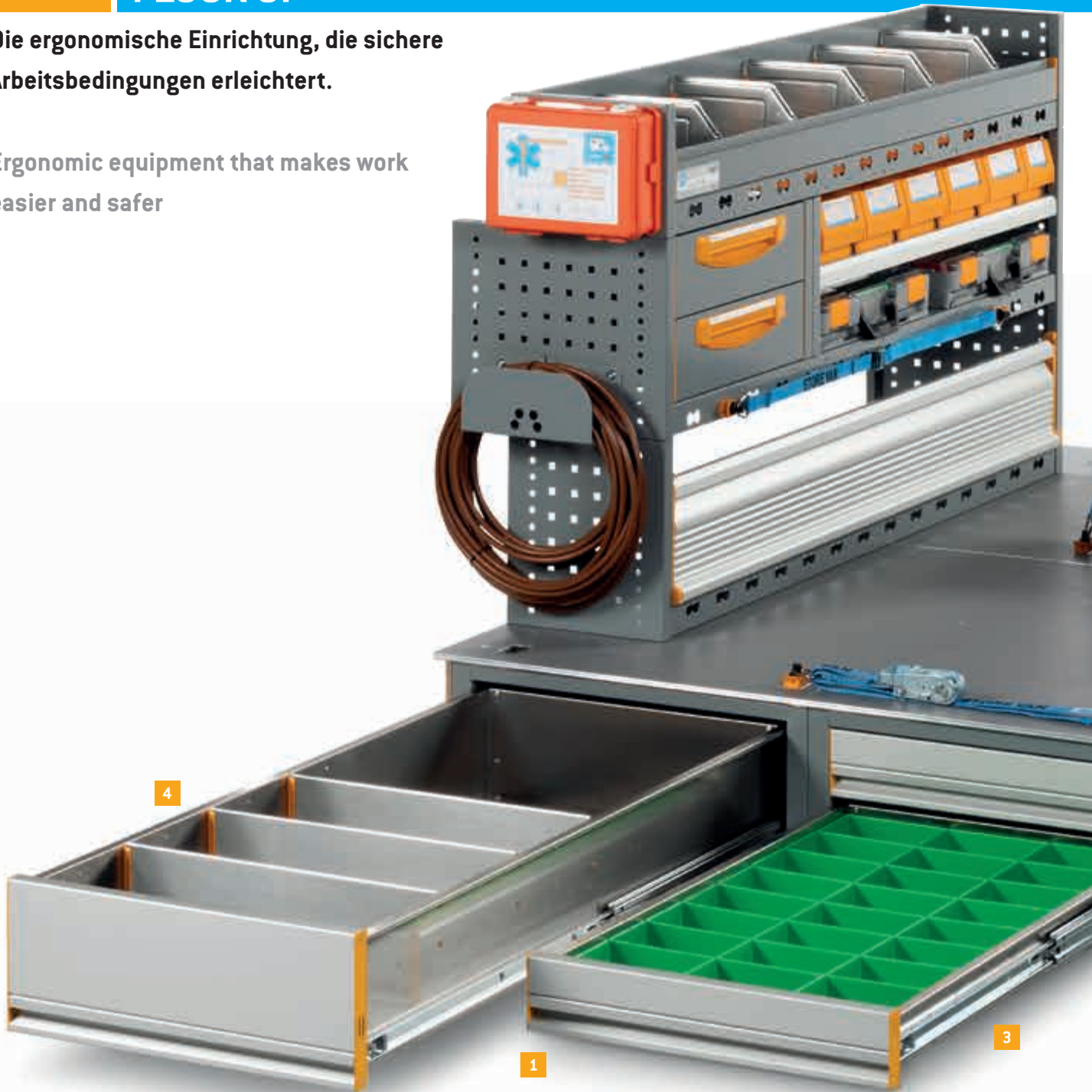

- 1 • Vorderseite aus Aluminium
- Aluminium front



- 2 • Aluminiumklappe
- Folding aluminium door



- 3 • Tragfähigkeit der Schublade 80 kg
- Drawer capacity 80 kg



- 4 • Bewegliche Trennwände aus Aluminium
- Moveable aluminium dividers



- 5 • Leichte und modulare Struktur
- Lightweight and modular structure



- 6 • Befestigungspunkte AIRLINE
- AIRLINE anchor points

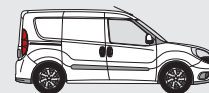

Die Unterbodenschubladen sind ein Schlüsselement des neuen FLOOR UP von Store Van, der Fahrzeugeinrichtung für Lieferwagen und Nutzfahrzeuge bestehend aus einem Unterflurmodul, das mit Fächern und Unterbodenschubladen ausgestattet ist. Sie wurde entwickelt, **um die Tragfähigkeit der leichten Nutzfahrzeuge mit weniger als 5 m³ Ladevolumen zu verbessern.**

Das Lager- und Handhabungssystem der geladenen Ware verbessert die Ergonomie und macht den Transport wendig und schnell. Dieses Ergebnis konnte dank der Einführung von besonders langen Unterbodenschubladen mit großem Innenvolumen für Lieferwagen und Nutzfahrzeuge erzielt werden, die sich am Heck und an der Seite im Bereich der Tür befinden.

Die Unterbodenschubladen kombinieren die hohe Tragfähigkeit von **80 kg pro Schublade** mit dem breitgefächerten Angebot an Trennelementen wie beweglichen Längs- und Quertrennwänden aus Aluminium und der Kunststoffbox in verschiedenen Größen, um die die darin enthaltene

Ladung zu trennen und aufzunehmen. Darüber hinaus verhindern die auf der gesamten Höhe angebrachten Seitenwände die Verschüttung des Materials während des Transports.

Als Alternative zu den Unterbodenschubladen kann eine Klappe vorgesehen werden, um einen Bereich zu schaffen, in dem größere bzw. schwerere Gegenstände eingeführt werden können, als in den Unterbodenschubladen.

Die obere Fläche der Fahrzeugeinrichtung besteht aus einer Bodenplatte aus Birkenbrettspertholz mit einer speziellen hochfesten Beschichtung und einem vom TÜV zertifizierten Reibungskoeffizient. Die Bodenplatte verfügt über **AIRLINE-Befestigungspunkte** mit einer Zugfestigkeit von 200 daN in Übereinstimmung mit der neuen EU-Richtlinie 2014/47/EU zur Sicherheit und Sicherung der Ladung.

Die Montage von FLOOR UP ist einfach. Die Komponenten aus Aluminium wie die Vorderseiten der Schubladen und die Trennwände verleihen ihr besondere Leichtigkeit.

- Schublade mit Blockierung in offener Stellung.
- Griff über die gesamte Schubladenlänge.
- Schublade komplett aus Aluminium.
- Schubladenschrank aus geschweißter Struktur.
- Quer- und Längsteiler.
- Schubladen H. 100 und H. 200.

The underfloor drawers are the key element of the new FLOOR UP by Store Van, the outfitting system for vans featuring a raised floor with storage compartments and underfloor drawers, designed to **improve the load capacity of commercial vehicles with a cargo volume of less than 5 m³.**

The goods storage and handling system improves ergonomics and makes transport easy and fast. This result was achieved thanks to the introduction of particularly long and spacious underfloor drawers for vans, placed at the rear and along the sides of the vehicle next to the doors.

The underfloor drawers combine high capacity, at **80 kg per drawer**, and a broad range of separation items such as longitudinal and transversal moveable aluminium dividers, and various-sized plastic boxes to separate and hold the items they contain. The full-height side walls also prevent any material spillage during transport.

As an alternative to the underfloor drawers, a hatch can be inserted with respect to those which can be inserted in the underfloor drawers.

The upper part of the outfitting is developed with a marine birch wood floor with special high-strength coating and TÜV-certified friction coefficient. The floor is fitted with **AIRLINE anchor points** with a pull force of 200 daN, in compliance with the new European directive 2014/47/EU regarding cargo safety and securing.

FLOOR UP is easy to assemble and the aluminium components, such as the drawer fronts and dividers, make it particularly light.

- Drawer with opening stopper.
- Handle along the entire length of the drawer.
- Drawer entirely in aluminium.
- Drawer cabinet frame in welded structure.
- Diagonal and longitudinal dividers.
- Drawers h100 and h200.

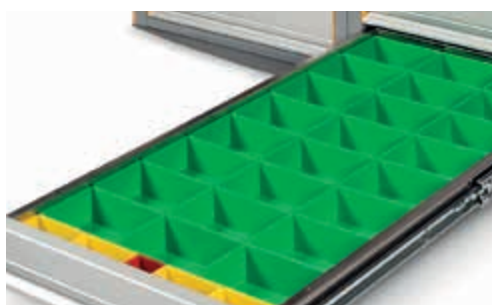



L1 H1

FIAT DOBLÒ
KASTENWAGEN - PANEL VAN

SAFETY

L1 H1 SAFETY

FAHRZEUGEINRICHTUNGSBEISPIELE - FITTINGS EXAMPLES

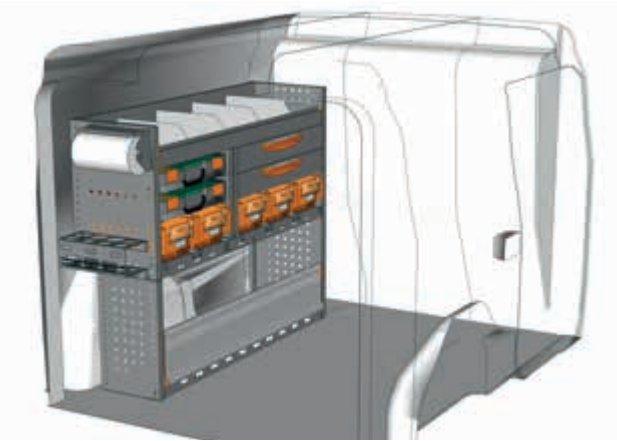

BEISPIEL - EXAMPLE

DO 1210 01*

B=1225 T=365 H=1000 mm - W=1225 D=365 H=1000 mm

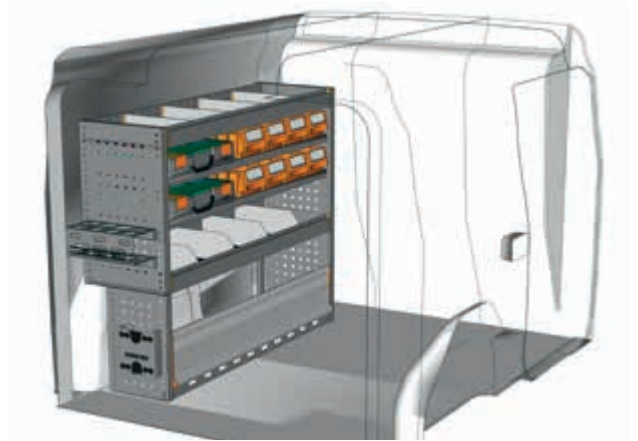
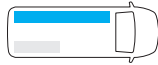

BEISPIEL - EXAMPLE

DO 1210 02*

B=1225 T=365 H=1000 mm - W=1225 D=365 H=1000 mm

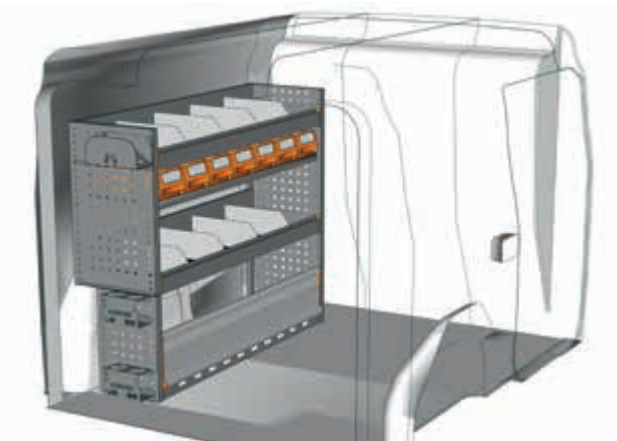
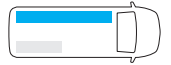

BEISPIEL - EXAMPLE

DO 1210 03*

B=1225 T=365 H=1000 mm - W=1225 D=365 H=1000 mm

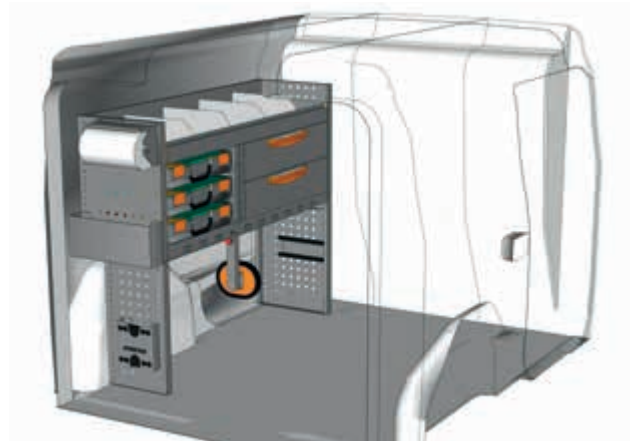
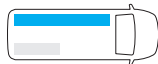

BEISPIEL - EXAMPLE

DO 1210 05*

B=1225 T=365 H=1000 mm - W=1225 D=365 H=1000 mm

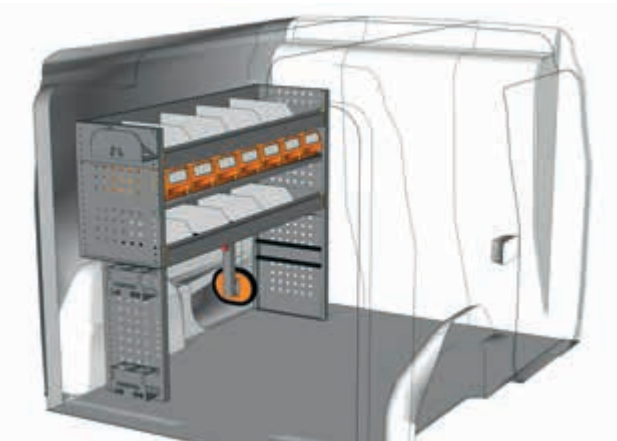

BEISPIEL - EXAMPLE

DO 1210 07*

B=1225 T=365 H=1000 mm - W=1225 D=365 H=1000 mm

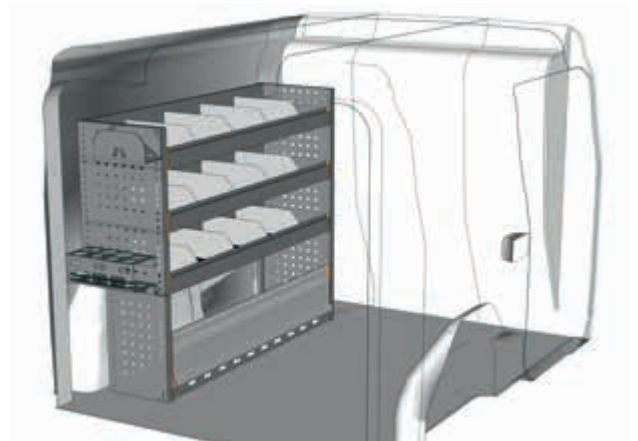

BEISPIEL - EXAMPLE

DO 1210 09*

B=1225 T=365 H=1000 mm - W=1225 D=365 H=1000 mm

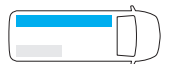

* Einschließlich Befestigungskit - Fixing kit included

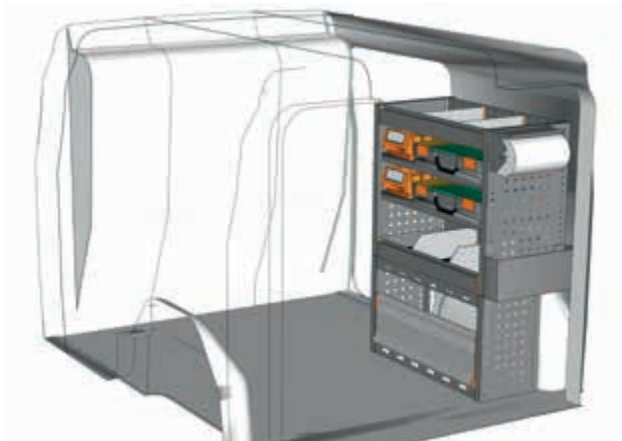
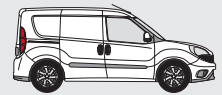

BEISPIEL - EXAMPLE

DO 0710 01*

B=717 T=365 H=1000 mm - W=717 D=365 H=1000 mm

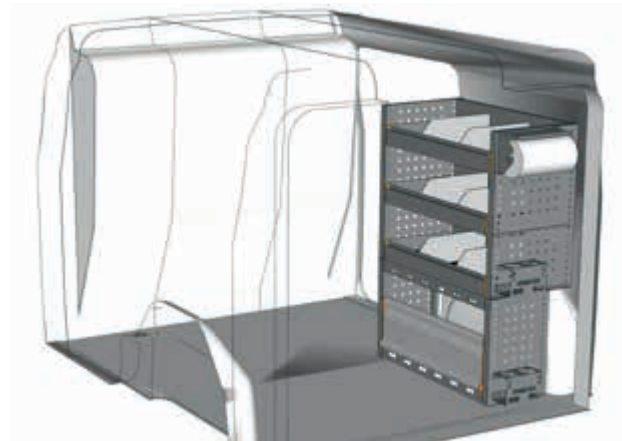

BEISPIEL - EXAMPLE

DO 0710 02*

B=717 T=365 H=1000 mm - W=717 D=365 H=1000 mm

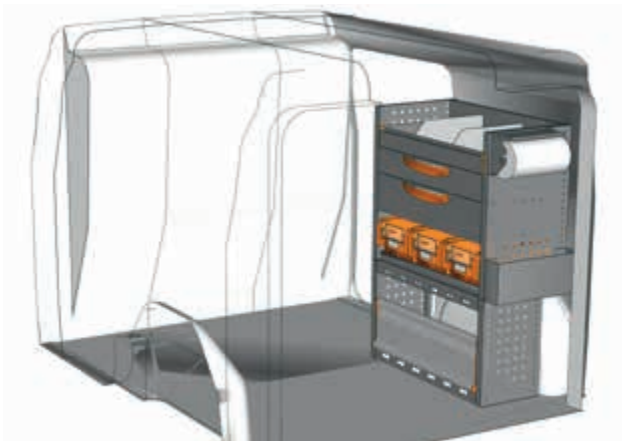
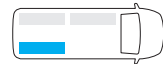

BEISPIEL - EXAMPLE

DO 0710 03*

B=717 T=365 H=1000 mm - W=717 D=365 H=1000 mm

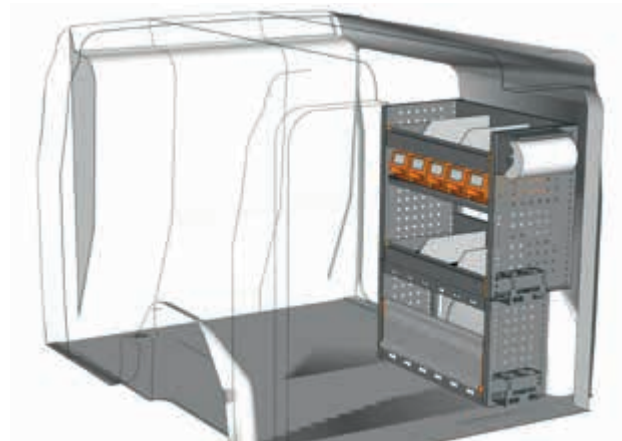
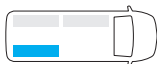

BEISPIEL - EXAMPLE

DO 0710 05*

B=717 T=365 H=1000 mm - W=717 D=365 H=1000 mm

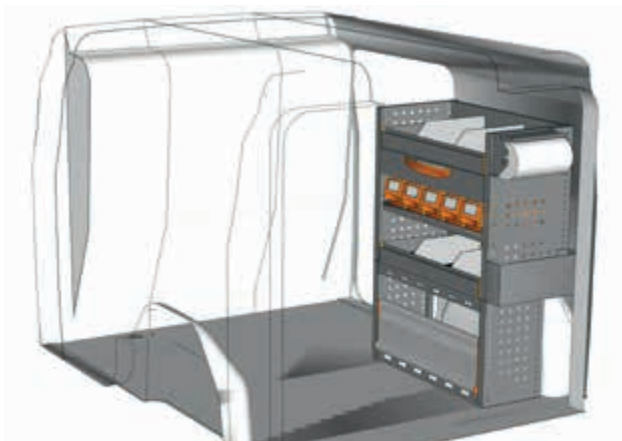
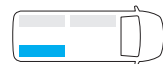

BEISPIEL - EXAMPLE

DO 0710 06*

B=717 T=365 H=1000 mm - W=717 D=365 H=1000 mm



**Haben Sie Ihre Einrichtung nicht gefunden?
Verlassen Sie sich auf die Profis für
Fahrzeugeinrichtungen.**

Auf der Rückseite dieses Katalogs
finden Sie die nächstgelegene
StoreVan Niederlassung.
Besuchen Sie unsere Web-Seite.

**Didn't find the equipment
you're looking for?
Leave it to our experts.**

See the back of this catalogue
and contact the nearest
StoreVan point or visit our website.



* Einschließlich Befestigungsset - Fixing kit included

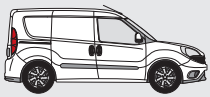

L1 H1

FIAT DOBLÒ
KASTENWAGEN - PANEL VAN

PROFESSIONAL

L1 H1 PROFESSIONAL

FAHRZEUGEINRICHTUNGSBEISPIELE - FITTINGS EXAMPLES

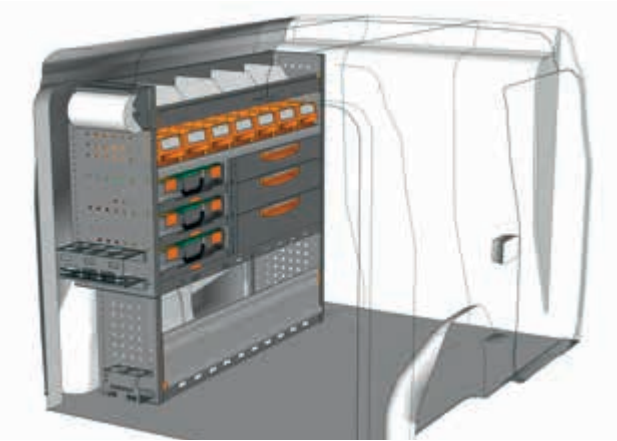

BEISPIEL - EXAMPLE

DO 1211 P1*

B=1225 T=365 H=1150 mm - W=1225 D=365 H=1150 mm

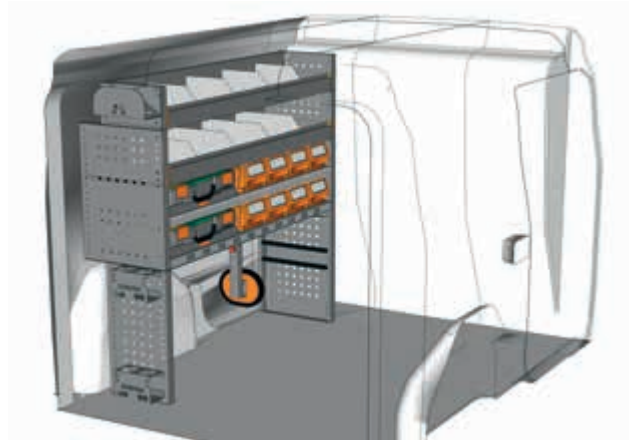
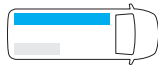

BEISPIEL - EXAMPLE

DO 1211 P2*

B=1225 T=365 H=1150 mm - W=1225 D=365 H=1150 mm

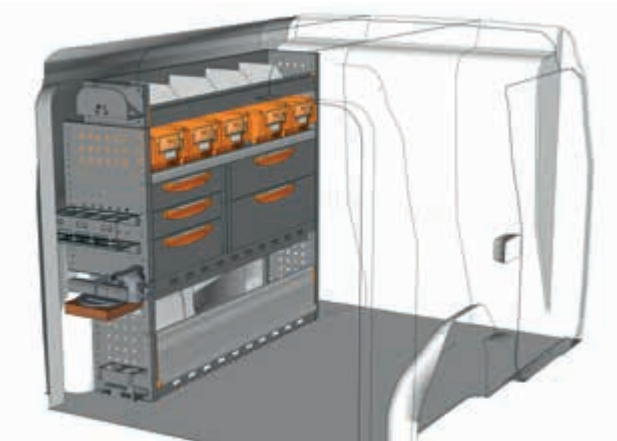
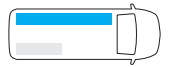

BEISPIEL - EXAMPLE

DO 1211 P3*

B=1225 T=365 H=1150 mm - W=1225 D=365 H=1150 mm

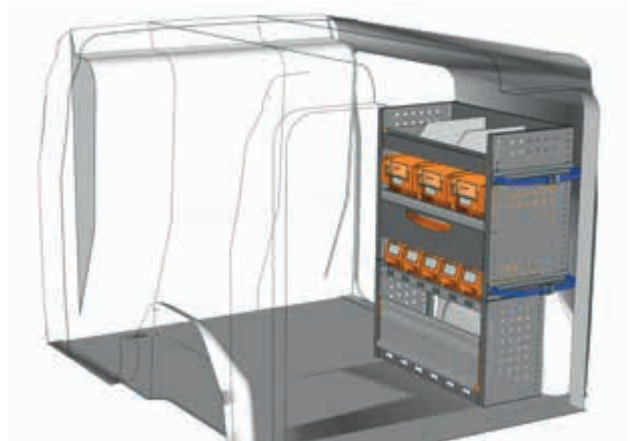
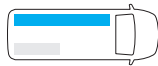

BEISPIEL - EXAMPLE

DO 0710 P1*

B=717 T=365 H=1000 mm - W=717 D=365 H=1000 mm

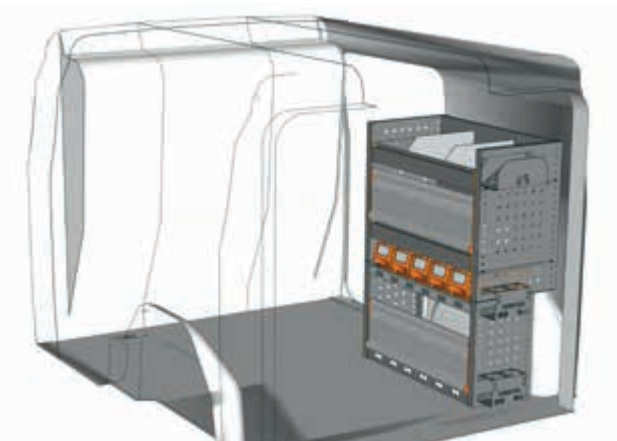

BEISPIEL - EXAMPLE

DO 0710 P2*

B=717 T=365 H=950 mm - W=717 D=365 H=950 mm

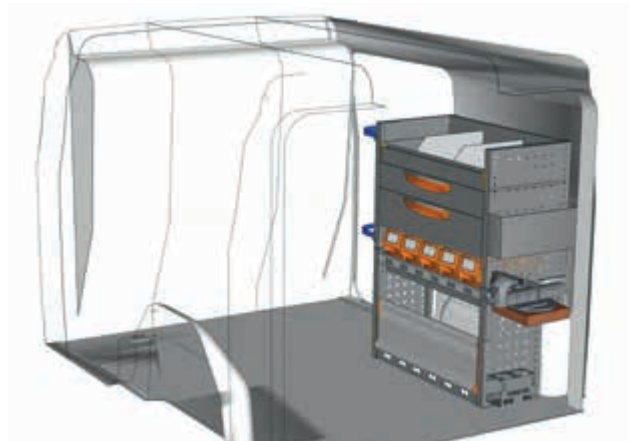
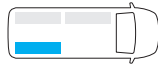

BEISPIEL - EXAMPLE

DO 0710 P3*

B=717 T=365 H=950 mm - W=717 D=365 H=950 mm



* Einschließlich Befestigungskit - Fixing kit included

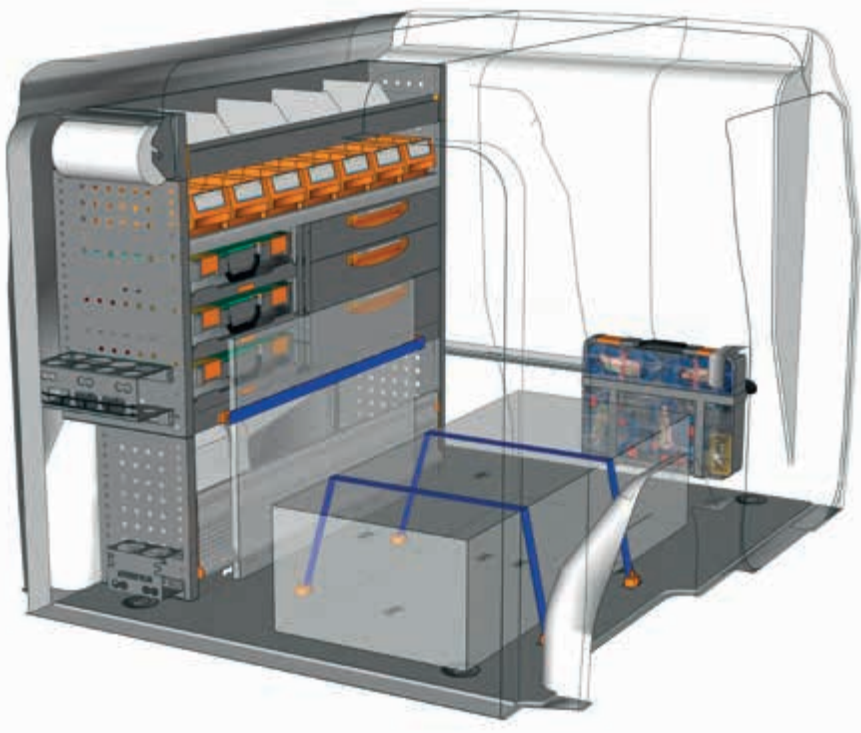
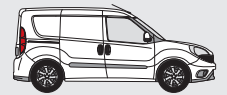

BEISPIEL - EXAMPLE

EXAMPLE DO L1H1 P1*



- | | |
|-------------------------|-------------------------|
| 1 x D0 1211 P1 | 1 x F22 SB CPV080 00 01 |
| 1 x F22 SF D010K1 B0 1S | 2 x F22 FC V22136 00 00 |
| 1 x F22 VT V22585 00 08 | 2 x F22 FC V22124 00 00 |
| 1 x F22 FC V18029 10 00 | 2 x F22 FC V22148 00 00 |
| 2 x F22 FC V22106 00 00 | 1 x F22 SB YELLOW 63 05 |
| 1 x F22 SB BOX080 00 01 | 4 x F22 FC V22582 00 00 |

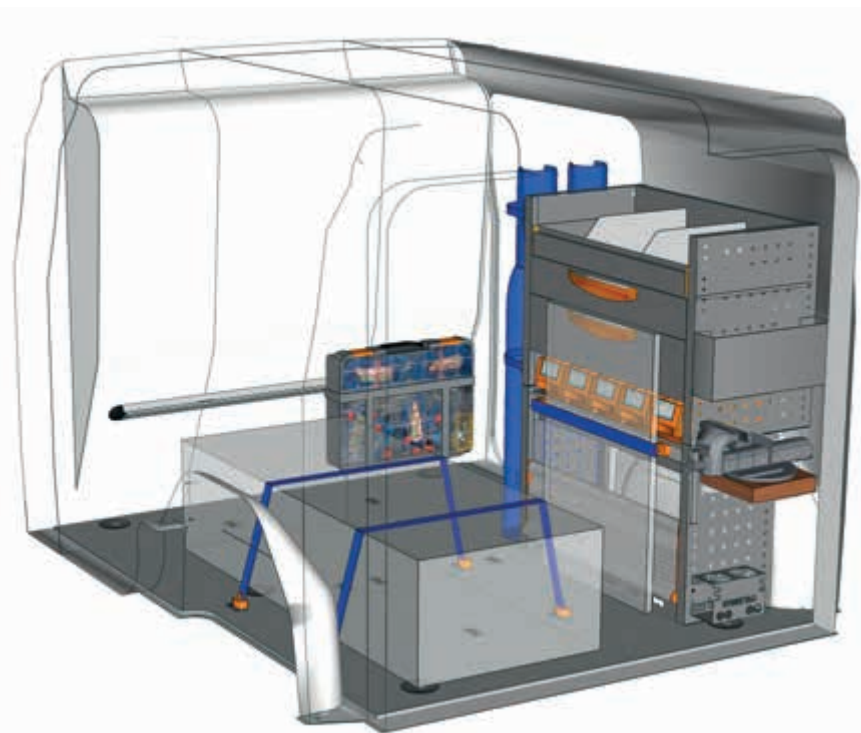

BEISPIEL - EXAMPLE

EXAMPLE DO L1H1 P2*



- | | |
|-------------------------|-------------------------|
| 1 x D0 0710 P3 | 1 x F22 SB CPV080 00 01 |
| 1 x F22 SF D010K1 B0 1S | 2 x F22 FC V22136 00 00 |
| 1 x F22 VT V22585 00 08 | 2 x F22 FC V22124 00 00 |
| 1 x F22 FC V18029 10 00 | 2 x F22 FC V22148 00 00 |
| 2 x F22 FC V22106 00 00 | 1 x F22 SB YELLOW 63 05 |
| 1 x F22 SB BOX080 00 01 | 4 x F22 FC V22582 00 00 |

**Haben Sie Ihre Einrichtung nicht gefunden?
Verlassen Sie sich auf die Profis für
Fahrzeugeinrichtungen.**

Auf der Rückseite dieses Katalogs
finden Sie die nächstgelegene
StoreVan Niederlassung.
Besuchen Sie unsere Web-Seite.

**Didn't find the equipment
you're looking for?
Leave it to our experts.**

See the back of this catalogue
and contact the nearest
StoreVan point or visit our website.



siehe Seiten 10/11
see pages 10/11

* Einschließlich Befestigungskit - Fixing kit included

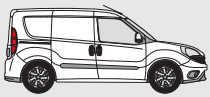

L1 H1

FIAT DOBLÒ
KASTENWAGEN - PANEL VAN

MOBILE

L1 H1 MOBILE

FAHRZEUGEINRICHTUNGSBEISPIELE - FITTINGS EXAMPLES

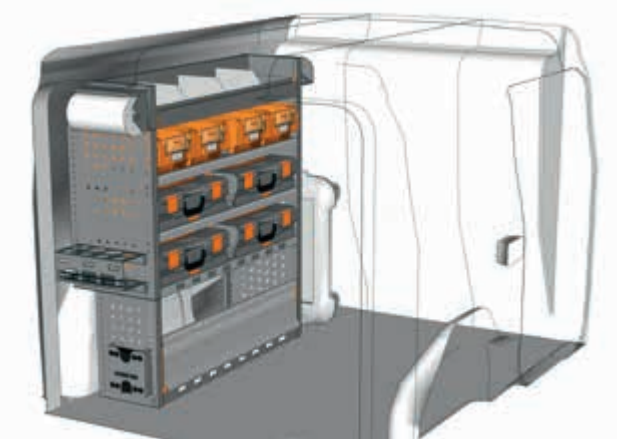

BEISPIEL - EXAMPLE

DO 1011 M1*

B=1016 T=365 H=1150 mm - W=1016 D=365 H=1150 mm

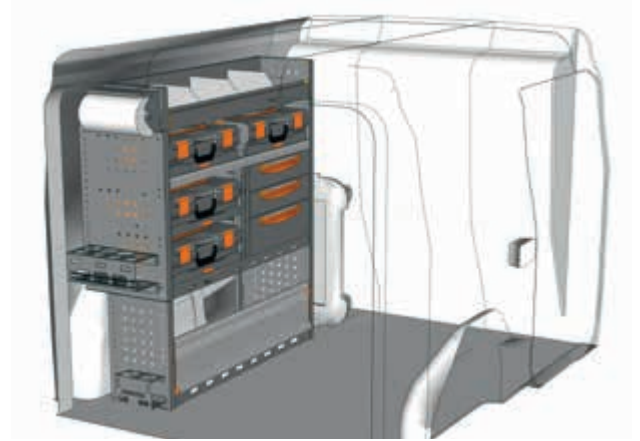
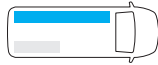

BEISPIEL - EXAMPLE

DO 1011 M2*

B=1016 T=365 H=1150 mm - W=1016 D=365 H=1150 mm

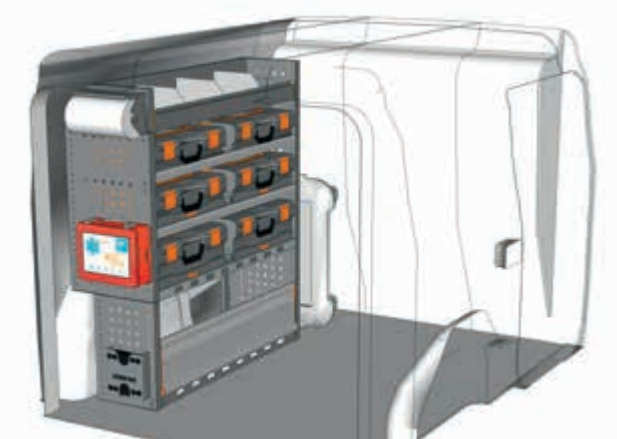
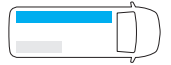

BEISPIEL - EXAMPLE

DO 1011 M3*

B=1016 T=365 H=1150 mm - W=1016 D=365 H=1150 mm

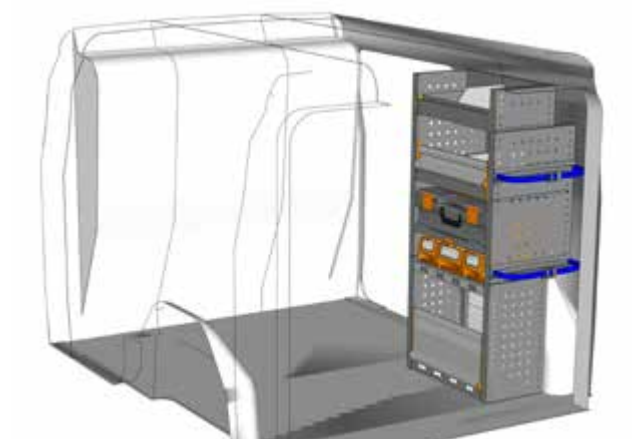
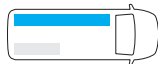

BEISPIEL - EXAMPLE

DO 0511 M1*

B=508 T=365 H=1150 mm - W=508 D=365 H=1150 mm

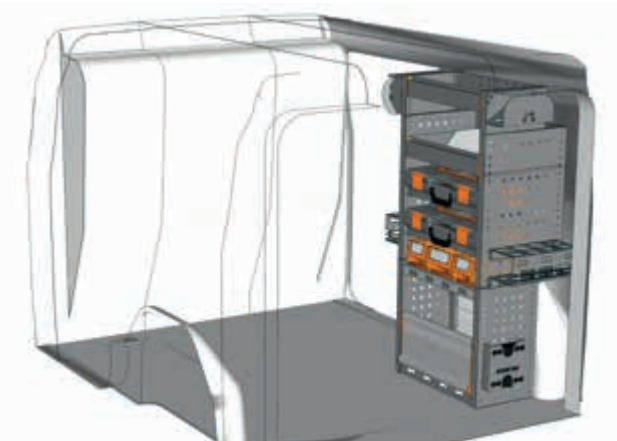

BEISPIEL - EXAMPLE

DO 0511 M2*

B=508 T=365 H=1150 mm - W=508 D=365 H=1150 mm

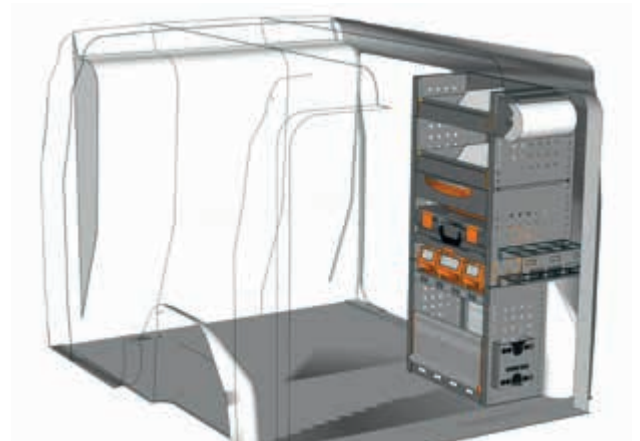
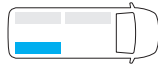

BEISPIEL - EXAMPLE

DO 0511 M3*

B=508 T=365 H=1150 mm - W=508 D=365 H=1150 mm



* Einschließlich Befestigungskit - Fixing kit included

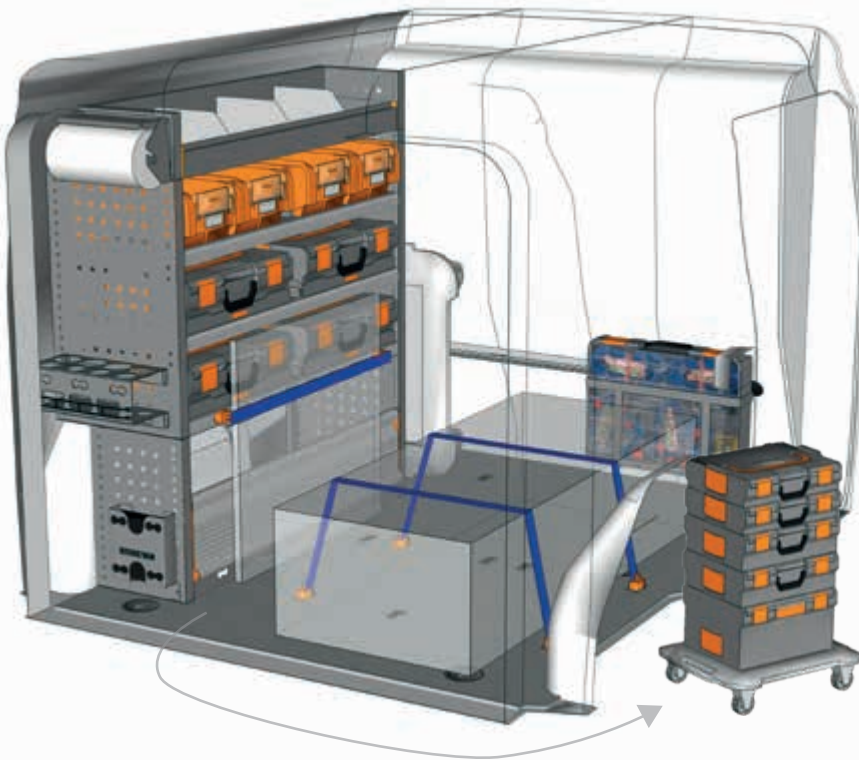
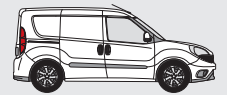

BEISPIEL - EXAMPLE

EXAMPLE DO L1H1 M1*

1 x DO 1011 M1	1 x F22 SB CPV080 00 01
1 x F22 SF D010K1 B0 1S	2 x F22 FC V22136 00 00
1 x F22 VT V22585 00 08	2 x F22 FC V22124 00 00
1 x F22 FC V18029 10 00	2 x F22 FC V22148 00 00
2 x F22 FC V22106 00 00	1 x F22 SB YELLOW 63 05
1 x F22 SB BOX080 00 01	4 x F22 FC V22582 00 00

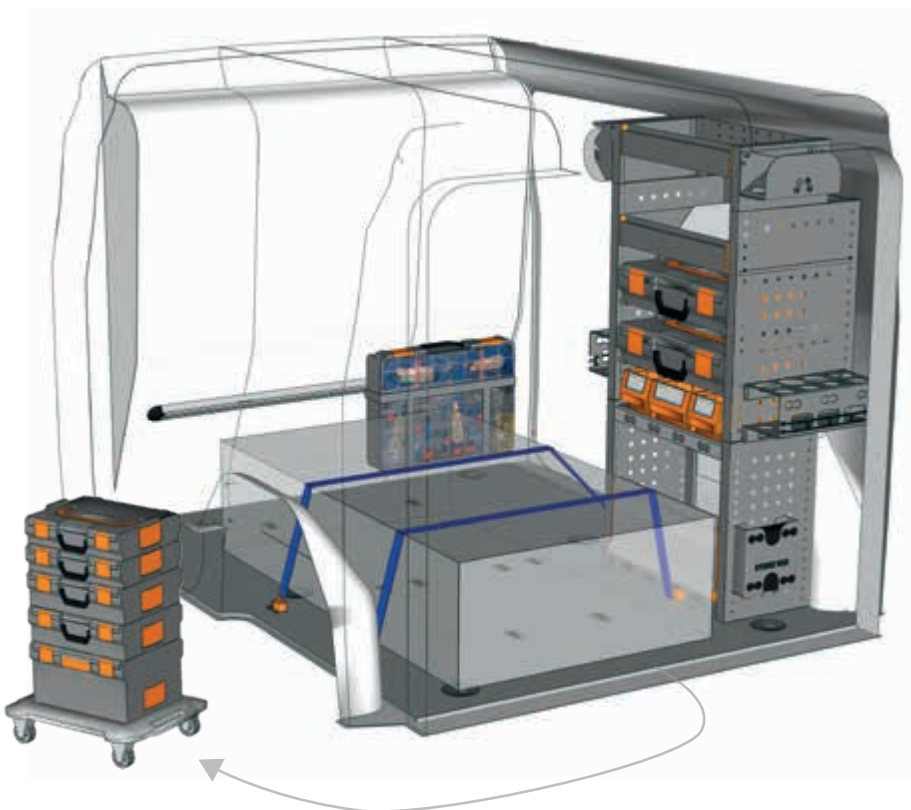

BEISPIEL - EXAMPLE

EXAMPLE DO L1H1 M2*

1 x DO 0511 M2	1 x F22 SB CPV080 00 01
1 x F22 SF D010K1 B0 1S	2 x F22 FC V22136 00 00
1 x F22 VT V22585 00 08	2 x F22 FC V22124 00 00
1 x F22 FC V18029 10 00	2 x F22 FC V22148 00 00
2 x F22 FC V22106 00 00	1 x F22 SB YELLOW 63 05
1 x F22 SB BOX080 00 01	4 x F22 FC V22582 00 00

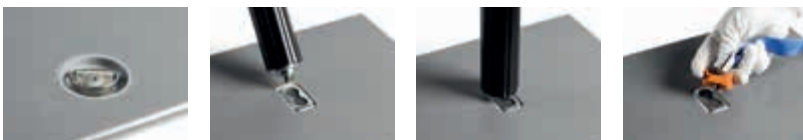

siehe Seiten 10/11
see pages 10/11

* Einschließlich Befestigungskit - Fixing kit included

Haben Sie Ihre Einrichtung nicht gefunden?
Verlassen Sie sich auf die Profis für Fahrzeugeinrichtungen.
Auf der Rückseite dieses Katalogs finden Sie die nächstgelegene StoreVan Niederlassung. Besuchen Sie unsere Web-Seite.

Didn't find the equipment you're looking for?
Leave it to our experts.
See the back of this catalogue and contact the nearest StoreVan point or visit our website.



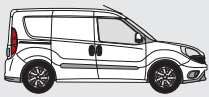

L1 H1

FIAT DOBLÒ
KASTENWAGEN - PANEL VAN

FLOOR UP 250

L1 H1

FLOOR UP BODENPLATTE H 250 mm
FLOORING H 250 mm

FAHRZEUGEINRICHTUNGSBEISPIELE - FITTINGS EXAMPLES

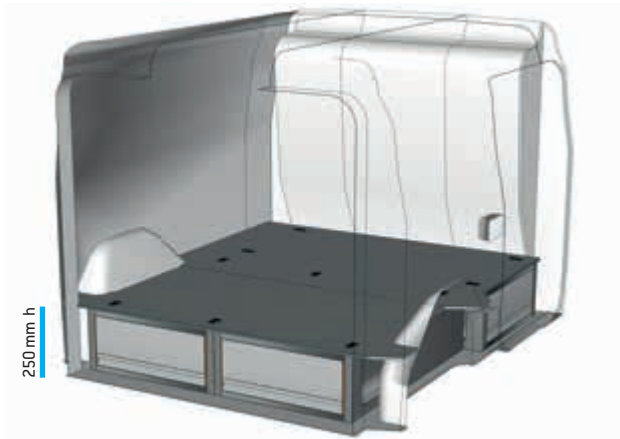

BEISPIEL - EXAMPLE

DO 0250 01*

B=1580 T=1489 H=269 mm - W=1580 D=1489 H=269 mm
(nur für Kabinenrückwand aus Vollblech / only for sheet steel bulkhead)

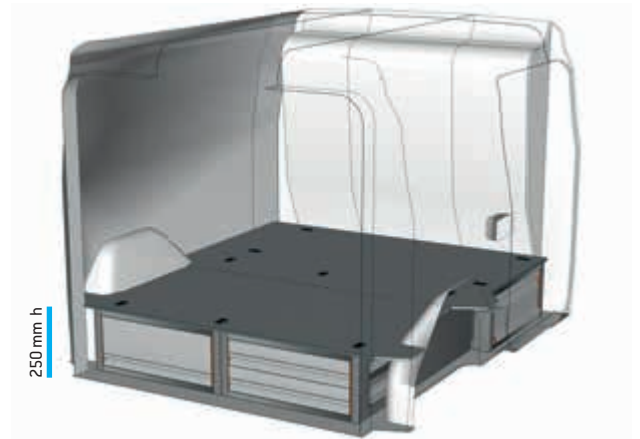

BEISPIEL - EXAMPLE

DO 0250 02*

B=1580 T=1489 H=269 mm - W=1580 D=1489 H=269 mm
(nur für Kabinenrückwand aus Vollblech / only for sheet steel bulkhead)

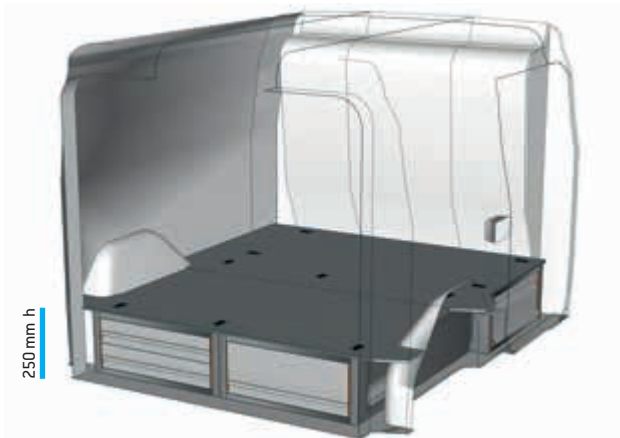

BEISPIEL - EXAMPLE

DO 0250 03*

B=1580 T=1489 H=269 mm - W=1580 D=1489 H=269 mm
(nur für Kabinenrückwand aus Vollblech / only for sheet steel bulkhead)

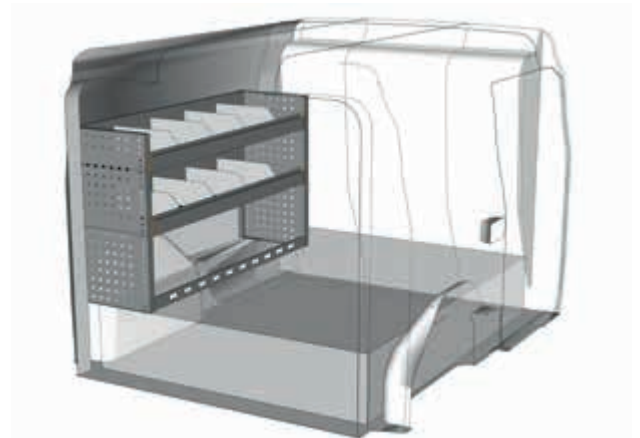

BEISPIEL - EXAMPLE

DO 1207 01*

B=1225 T=365 H=700 mm - W=1225 D=365 H=700 mm

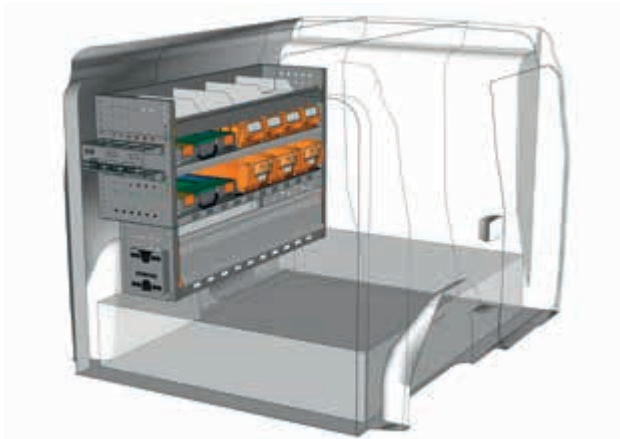
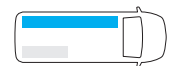

BEISPIEL - EXAMPLE

DO 1208 01*

B=1225 T=365 H=800 mm - W=1225 D=365 H=800 mm

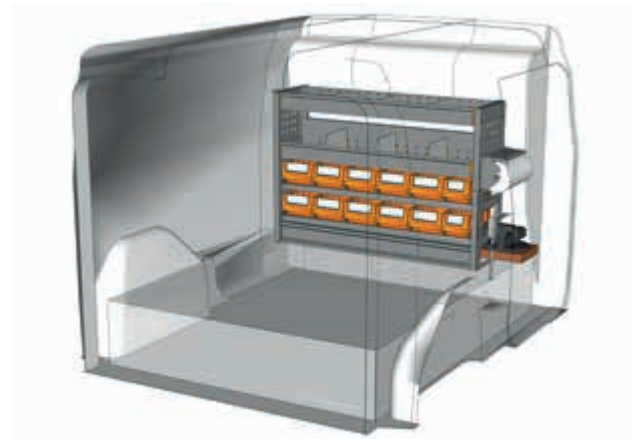
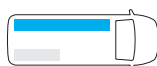

BEISPIEL - EXAMPLE

DO 1007 01*

B=1016 T=265 H=700 mm - W=1016 D=265 H=700 mm



* Einschließlich Befestigungskit - Fixing kit included

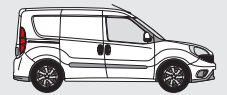

FAHRZEUGEINRICHTUNGSBEISPIELE - FITTINGS EXAMPLES

BODENPLATTE H 250 mm FLOORING H 250 mm **FLOOR UP**

L1 H1

KASTENWAGEN - PANEL VAN
FIAT DOBLÒ

FLOOR UP 250

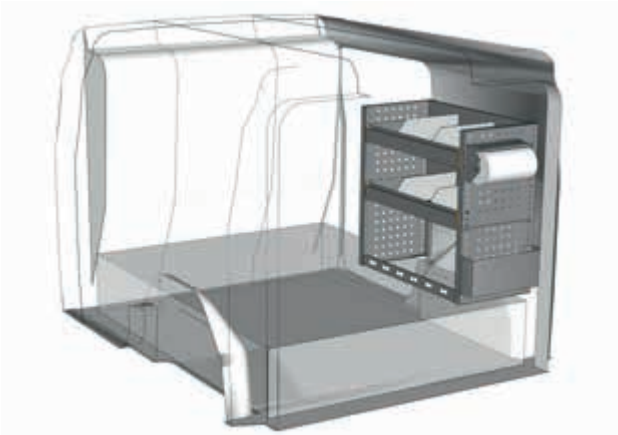

BEISPIEL - EXAMPLE

DO 0707 01*

B=717 T=365 H=700 mm - W=717 D=365 H=700 mm

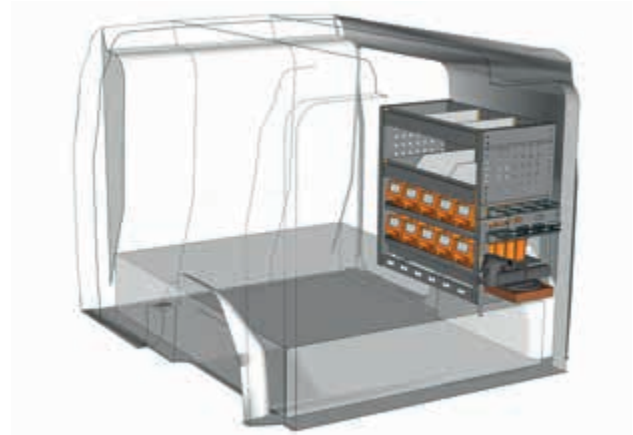
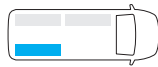

BEISPIEL - EXAMPLE

DO 0707 02*

B=717 T=365 H=700 mm - W=717 D=365 H=700 mm

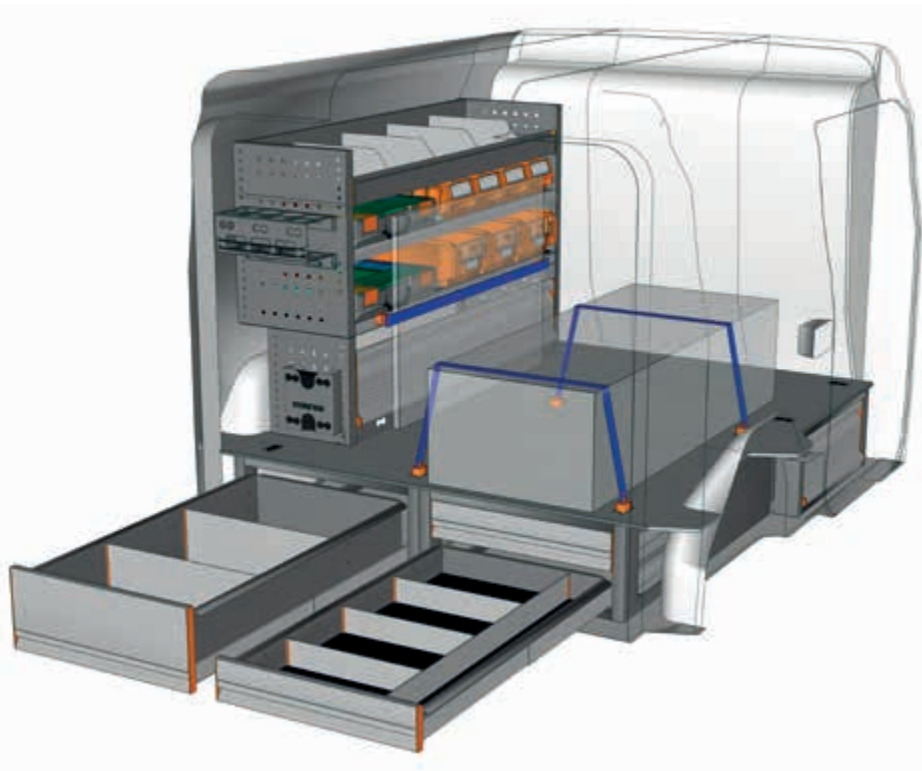
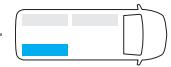

BEISPIEL - EXAMPLE

EXAMPLE DO L1H1 F1*

- 1 x DO 0250 02
- 1 x DO 1208 01
- 1 x E8 093058 B4
- 1 x E8 093058 D0
- 1 x E8 093058 F0
- 1 x E8 108058 C4
- 3 x F22 FC V22136 00 00



siehe Seiten 10/11
see pages 10/11

* Einschließlich Befestigungskit - Fixing kit included

Haben Sie Ihre Einrichtung nicht gefunden?
Verlassen Sie sich auf die Profis für Fahrzeugeinrichtungen.

Auf der Rückseite dieses Katalogs finden Sie die nächstgelegene StoreVan Niederlassung. Besuchen Sie unsere Web-Seite.

Didn't find the equipment you're looking for?
Leave it to our experts.

See the back of this catalogue and contact the nearest StoreVan point or visit our website.



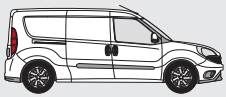

L2 H1

FIAT DOBLÒ
KASTENWAGEN - PANEL VAN

SAFETY

L2 H1 SAFETY

FAHRZEUGEINRICHTUNGSBEISPIELE - FITTINGS EXAMPLES

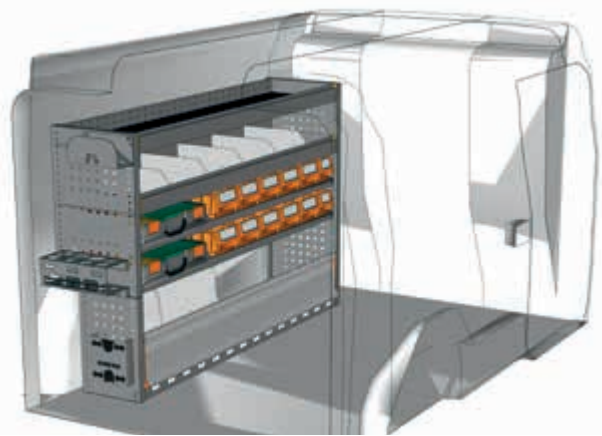

BEISPIEL - EXAMPLE

DO 1510 01*

B=1524 T=365 H=1000 mm - W=1524 D=365 H=1000 mm

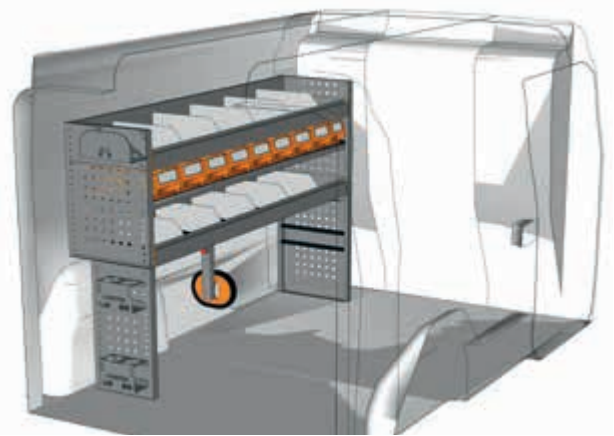
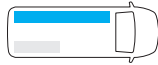

BEISPIEL - EXAMPLE

DO 1510 03*

B=1524 T=365 H=1000 mm - W=1524 D=365 H=1000 mm

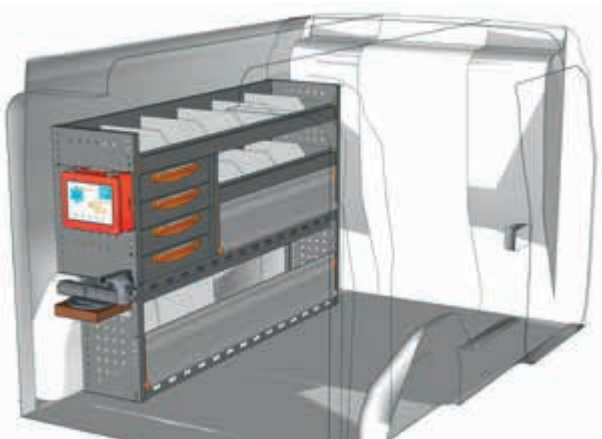

BEISPIEL - EXAMPLE

DO 1510 04*

B=1524 T=365 H=1000 mm - W=1524 D=365 H=1000 mm

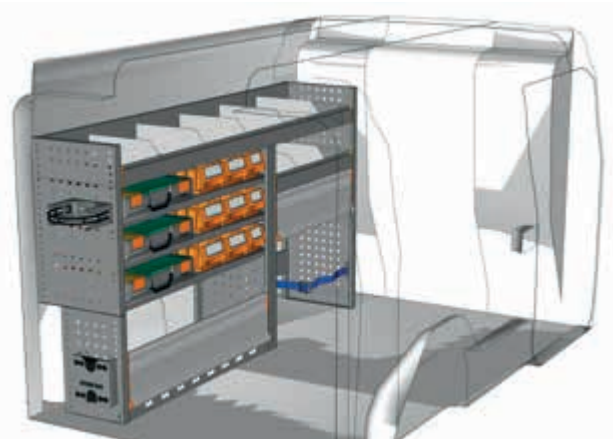
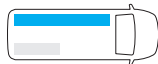

BEISPIEL - EXAMPLE

DO 1710 01*

B=1733 T=365 H=1000 mm - W=1733 D=365 H=1000 mm
(nur für Kabinenrückwand aus Vollblech / only for sheet steel bulkhead)

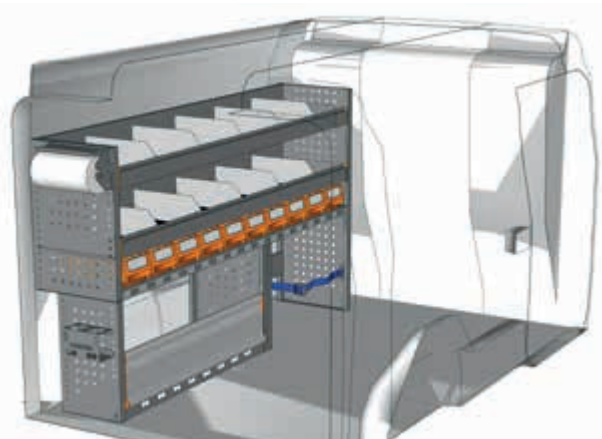
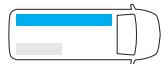

BEISPIEL - EXAMPLE

DO 1710 02*

B=1733 T=365 H=1000 mm - W=1733 D=365 H=1000 mm
(nur für Kabinenrückwand aus Vollblech / only for sheet steel bulkhead)

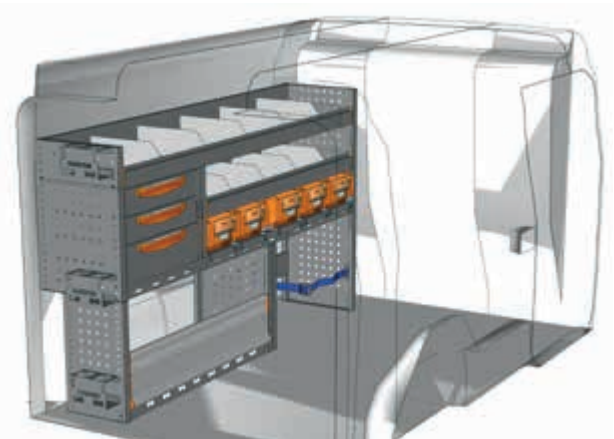

BEISPIEL - EXAMPLE

DO 1710 03*

B=1733 T=365 H=1000 mm - W=1733 D=365 H=1000 mm
(nur für Kabinenrückwand aus Vollblech / only for sheet steel bulkhead)

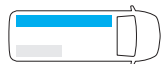

* Einschließlich Befestigungskit - Fixing kit included

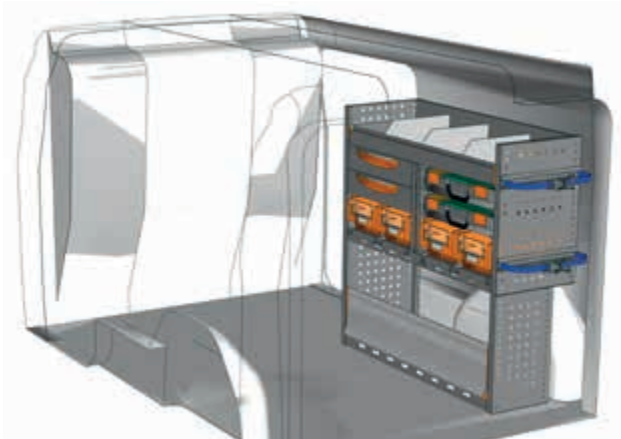
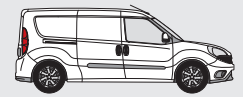

BEISPIEL - EXAMPLE

DO 1010 01*

B=1016 T=365 H=1000 mm - W=1016 D=365 H=1000 mm

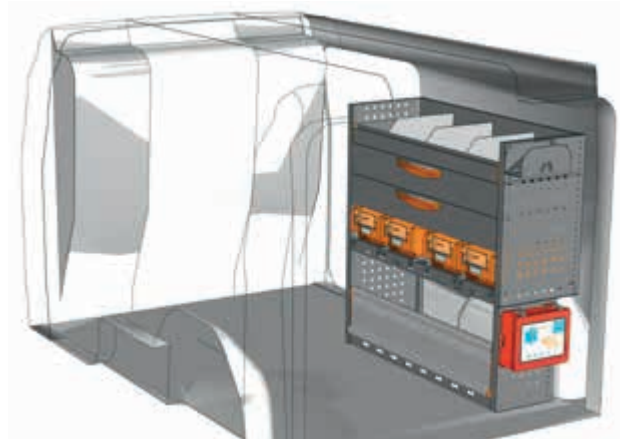

BEISPIEL - EXAMPLE

DO 1010 02*

B=1016 T=365 H=1000 mm - W=1016 D=365 H=1000 mm

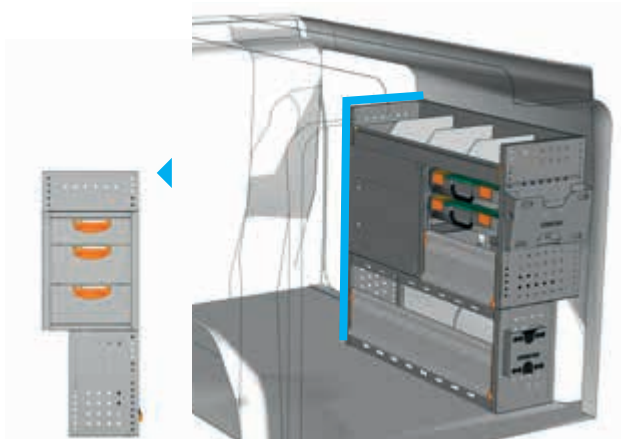

BEISPIEL - EXAMPLE

DO 1010 03*

B=1016 T=365 H=1000 mm - W= 1016 D=365 H=1000 mm

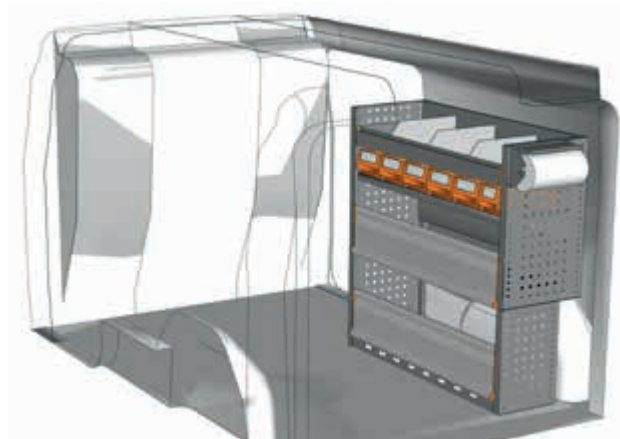
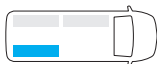

BEISPIEL - EXAMPLE

DO 1010 04*

B=1016 T=365 H=1000 mm - W=1016 D=365 H=1000 mm

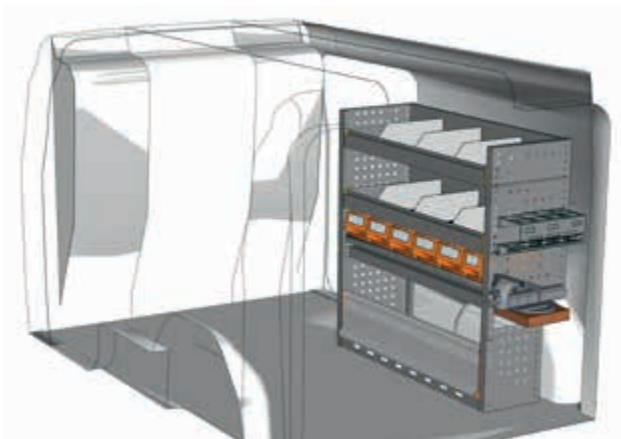
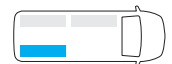

BEISPIEL - EXAMPLE

DO 1010 07*

B=1016 T=365 H=1000 mm - W=1016 D=365 H=1000 mm



**Haben Sie Ihre Einrichtung nicht gefunden?
Verlassen Sie sich auf die Profis für
Fahrzeugeinrichtungen.**

Auf der Rückseite dieses Katalogs
finden Sie die nächstgelegene
StoreVan Niederlassung.
Besuchen Sie unsere Web-Seite.

**Didn't find the equipment
you're looking for?
Leave it to our experts.**

See the back of this catalogue
and contact the nearest
StoreVan point or visit our website.



* Einschließlich Befestigungskit - Fixing kit included

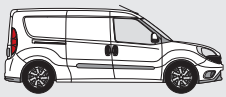

L2 H1

FIAT DOBLÒ
KASTENWAGEN - PANEL VAN

PROFESSIONAL

L2 H1 PROFESSIONAL

FAHRZEUGEINRICHTUNGSBEISPIELE - FITTINGS EXAMPLES

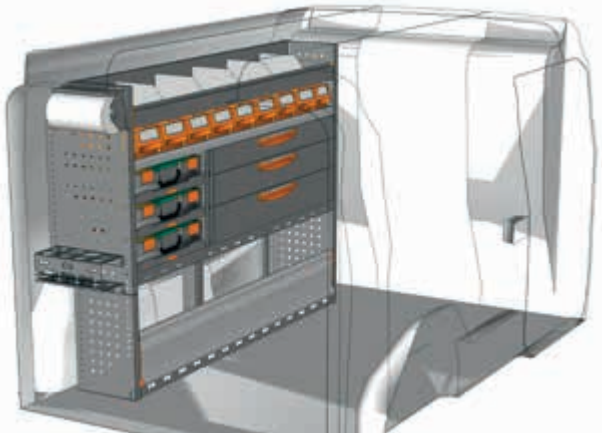

BEISPIEL - EXAMPLE

DO 1511 P1*

B=1524 T=365 H=1150 mm - W=1524 D=365 H=1150 mm

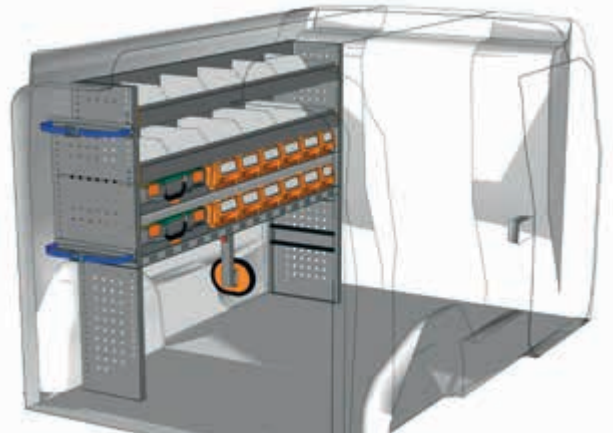
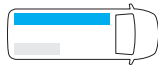

BEISPIEL - EXAMPLE

DO 1511 P2*

B=1524 T=365 H=1150 mm - W=1524 D=365 H=1150 mm

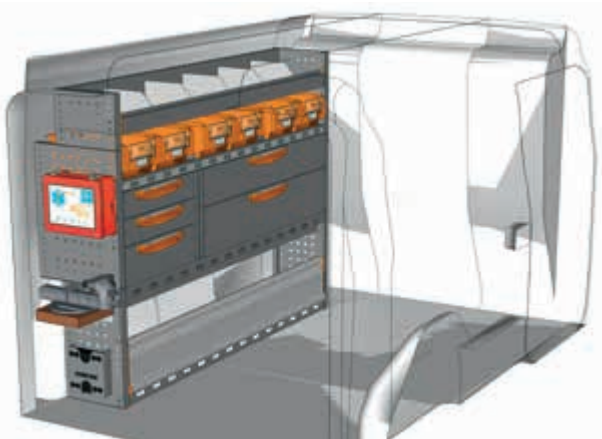
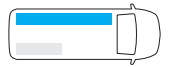

BEISPIEL - EXAMPLE

DO 1511 P3*

B=1524 T=365 H=1150 mm - W=1524 D=365 H=1150 mm

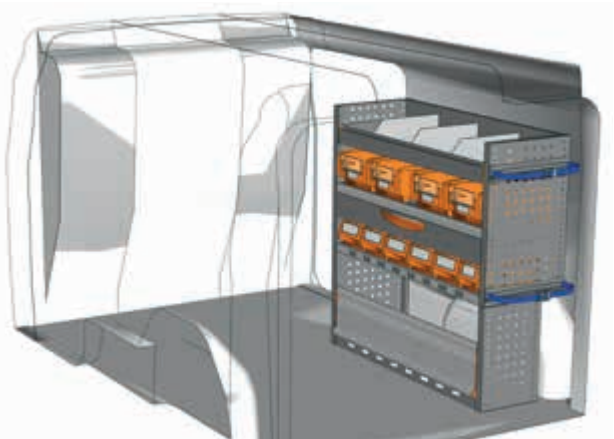
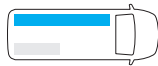

BEISPIEL - EXAMPLE

DO 1010 P1*

B=1016 T=365 H=1000 mm - W=1016 D=365 H=1000 mm

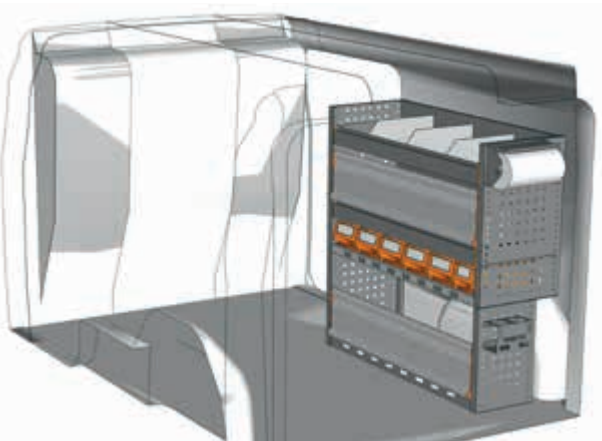

BEISPIEL - EXAMPLE

DO 1010 P2*

B=1016 T=365 H=1000 mm - W=1016 D=365 H=1000 mm

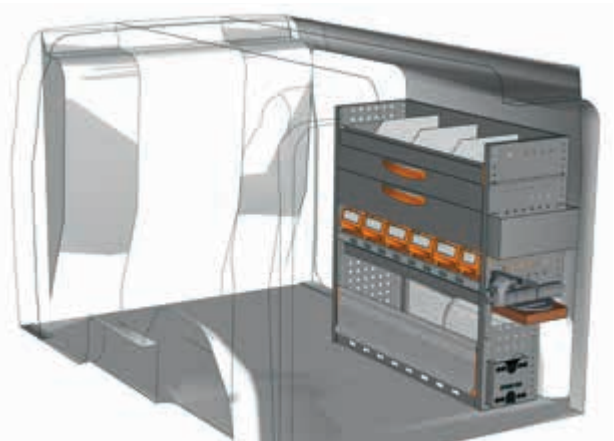

BEISPIEL - EXAMPLE

DO 1010 P3*

B=1016 T=365 H=1000 mm - W=1016 D=365 H=1000 mm



* Einschließlich Befestigungskit - Fixing kit included

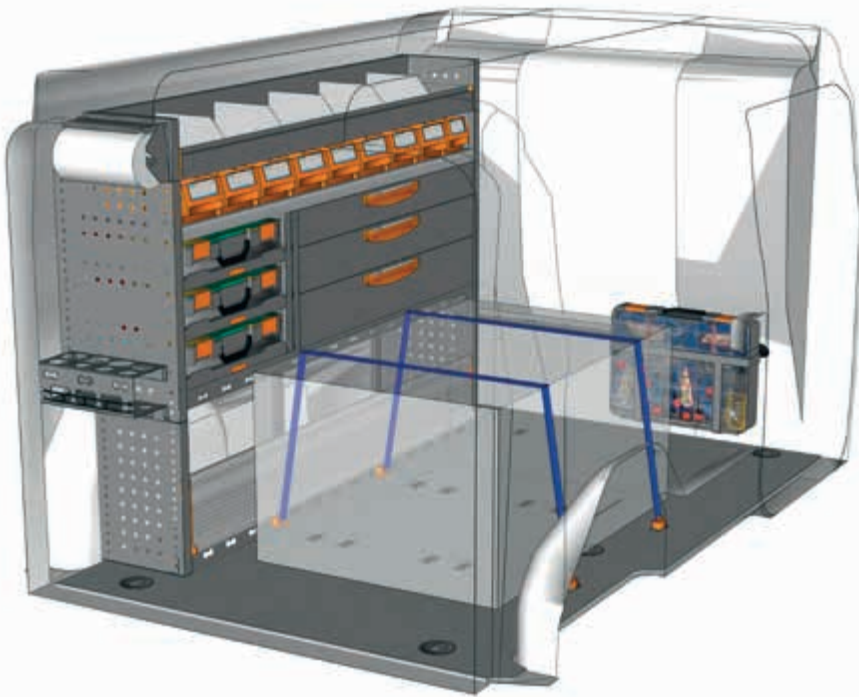
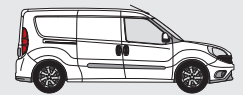

BEISPIEL - EXAMPLE

EXAMPLE DO L2H1 P1*

- | | |
|-------------------------|-------------------------|
| 1 x D0 1511 P1 | 1 x F22 SB CPV080 00 01 |
| 1 x F22 SF D020K1 B0 1S | 2 x F22 FC V22136 00 00 |
| 1 x F22 VT V22585 00 08 | 2 x F22 FC V22124 00 00 |
| 1 x F22 FC V18029 10 00 | 2 x F22 FC V22148 00 00 |
| 2 x F22 FC V22106 00 00 | 1 x F22 SB YELLOW 63 05 |
| 1 x F22 SB BOX080 00 01 | 4 x F22 FC V22582 00 00 |

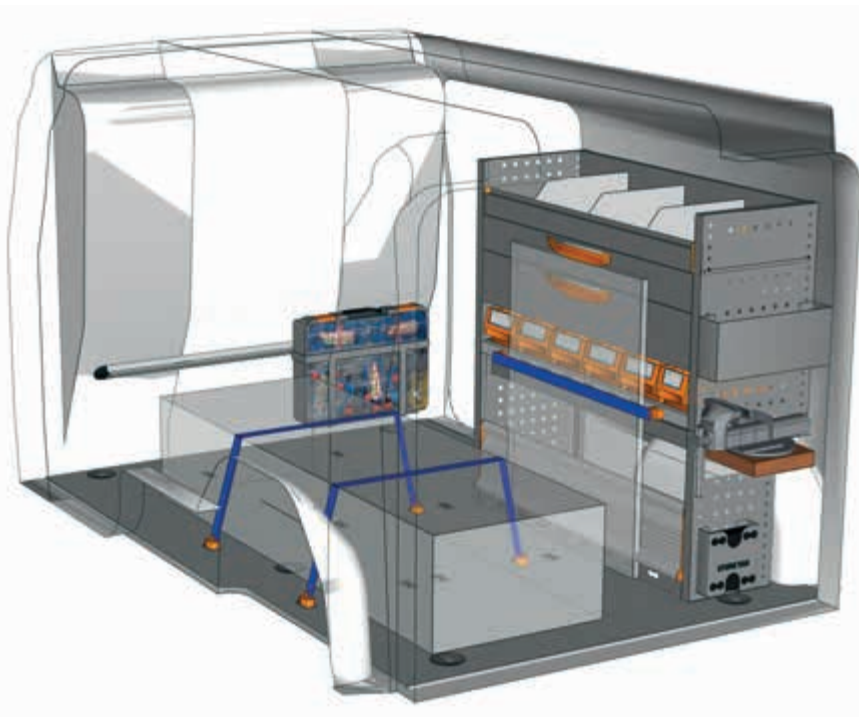

BEISPIEL - EXAMPLE

EXAMPLE DO L2H1 P2*

- | | |
|-------------------------|-------------------------|
| 1 x D0 1010 P3 | 1 x F22 SB CPV080 00 01 |
| 1 x F22 SF D020K1 B0 1S | 2 x F22 FC V22136 00 00 |
| 1 x F22 VT V22585 00 08 | 2 x F22 FC V22124 00 00 |
| 1 x F22 FC V18029 10 00 | 2 x F22 FC V22148 00 00 |
| 2 x F22 FC V22106 00 00 | 1 x F22 SB YELLOW 63 05 |
| 1 x F22 SB BOX080 00 01 | 4 x F22 FC V22582 00 00 |



siehe Seiten 10/11
see pages 10/11

* Einschließlich Befestigungskit - Fixing kit included

Haben Sie Ihre Einrichtung nicht gefunden?
Verlassen Sie sich auf die Profis für Fahrzeugeinrichtungen.
Auf der Rückseite dieses Katalogs finden Sie die nächstgelegene StoreVan Niederlassung. Besuchen Sie unsere Web-Seite.

Didn't find the equipment you're looking for?
Leave it to our experts.
See the back of this catalogue and contact the nearest StoreVan point or visit our website.



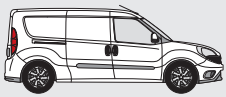

L2 H1

FIAT DOBLÒ
KASTENWAGEN - PANEL VAN

MOBILE

L2 H1 MOBILE

FAHRZEUGEINRICHTUNGSBEISPIELE - FITTINGS EXAMPLES

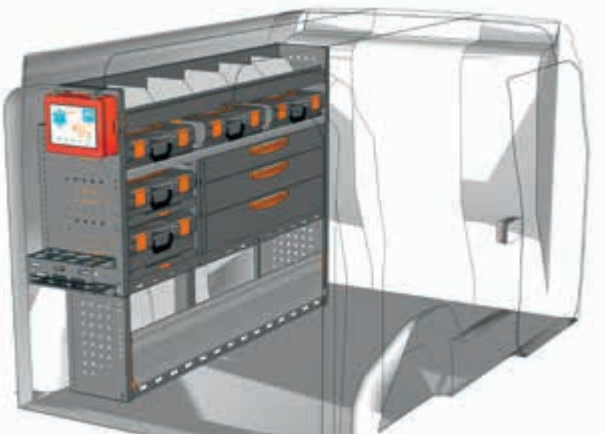

BEISPIEL - EXAMPLE

DO 1511 M1*

B=1524 T=365 H=1150 mm - W=1524 D=365 H=1150 mm

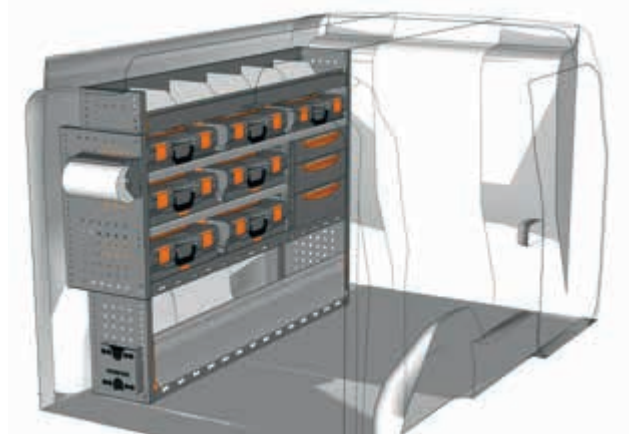
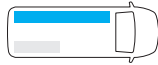

BEISPIEL - EXAMPLE

DO 1511 M2*

B= 1524 T=365 H=1150 mm - W= 1524 D=365 H=1150 mm

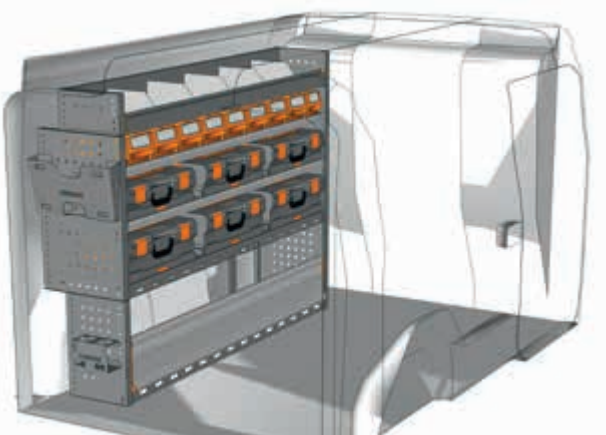
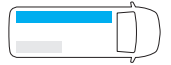

BEISPIEL - EXAMPLE

DO 1511 M3*

B= 1524 T=365 H=1150 mm - W=1524 D=365 H=1150 mm

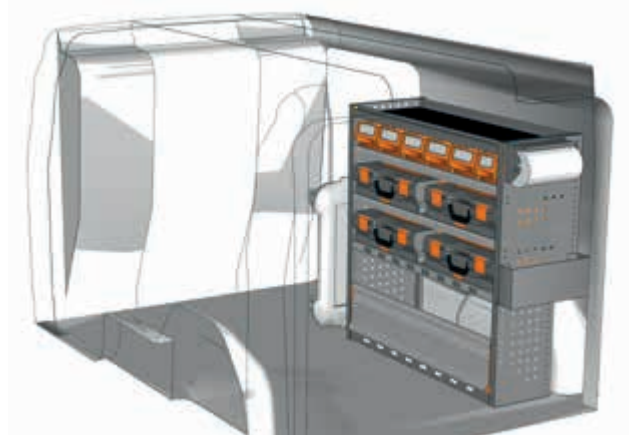
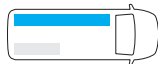

BEISPIEL - EXAMPLE

DO 1010 M1*

B=1016 T=365 H=1000 mm - W=1016 D=365 H=1000 mm

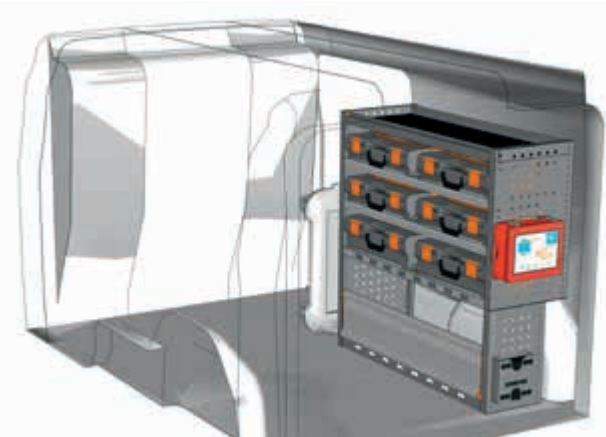

BEISPIEL - EXAMPLE

DO 1010 M2*

B=1016 T=365 H=1000 mm - W=1016 D=365 H=1000 mm

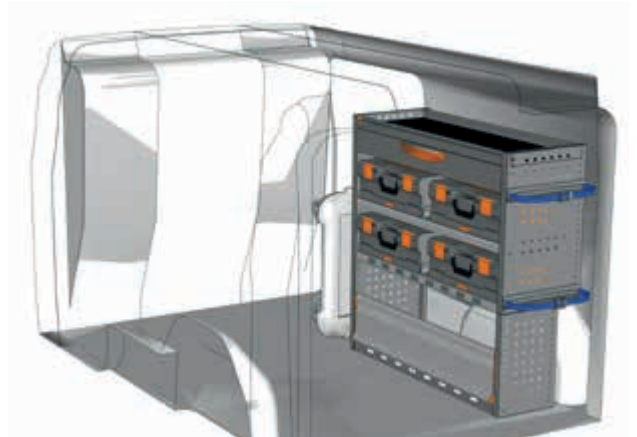
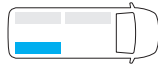

BEISPIEL - EXAMPLE

DO 1010 M3*

B=1016 T=365 H=1000 mm - W=1016 D=365 H=1000 mm



* Einschließlich Befestigungskit - Fixing kit included

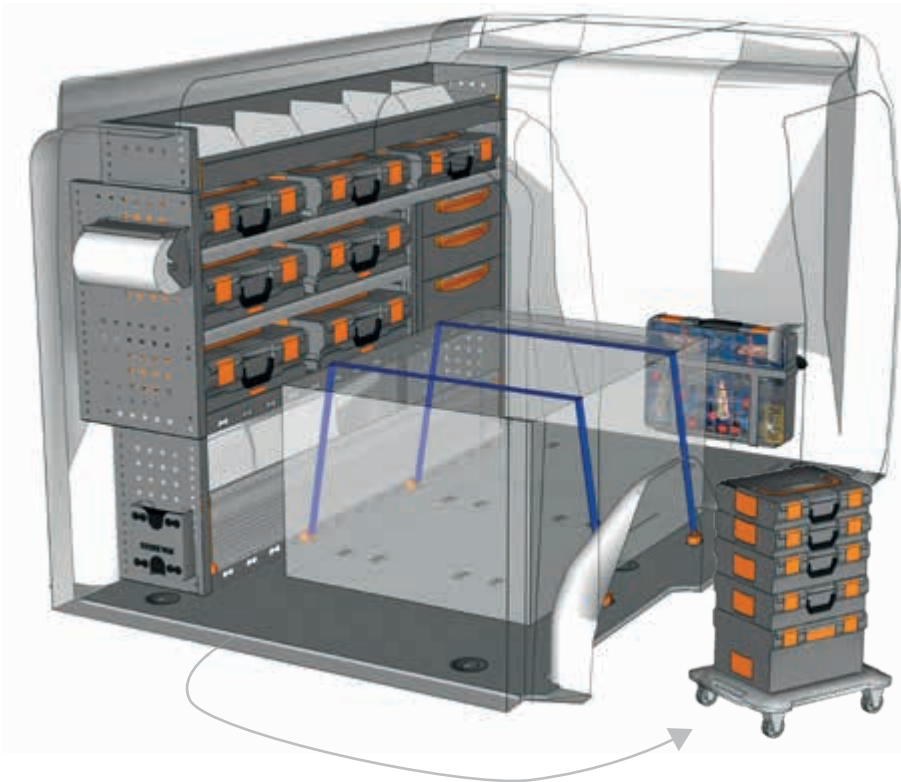
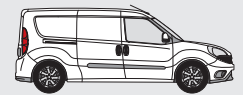

BEISPIEL - EXAMPLE

EXAMPLE DO L2H1 M1*

- | | |
|-------------------------|-------------------------|
| 1 x D0 1511 M1 | 1 x F22 SB CPV080 00 01 |
| 1 x F22 SF D020K1 B0 1S | 2 x F22 FC V22136 00 00 |
| 1 x F22 VT V22585 00 08 | 2 x F22 FC V22124 00 00 |
| 1 x F22 FC V18029 10 00 | 2 x F22 FC V22148 00 00 |
| 2 x F22 FC V22106 00 00 | 1 x F22 SB YELLOW 63 05 |
| 1 x F22 SB BOX080 00 01 | 4 x F22 FC V22582 00 00 |

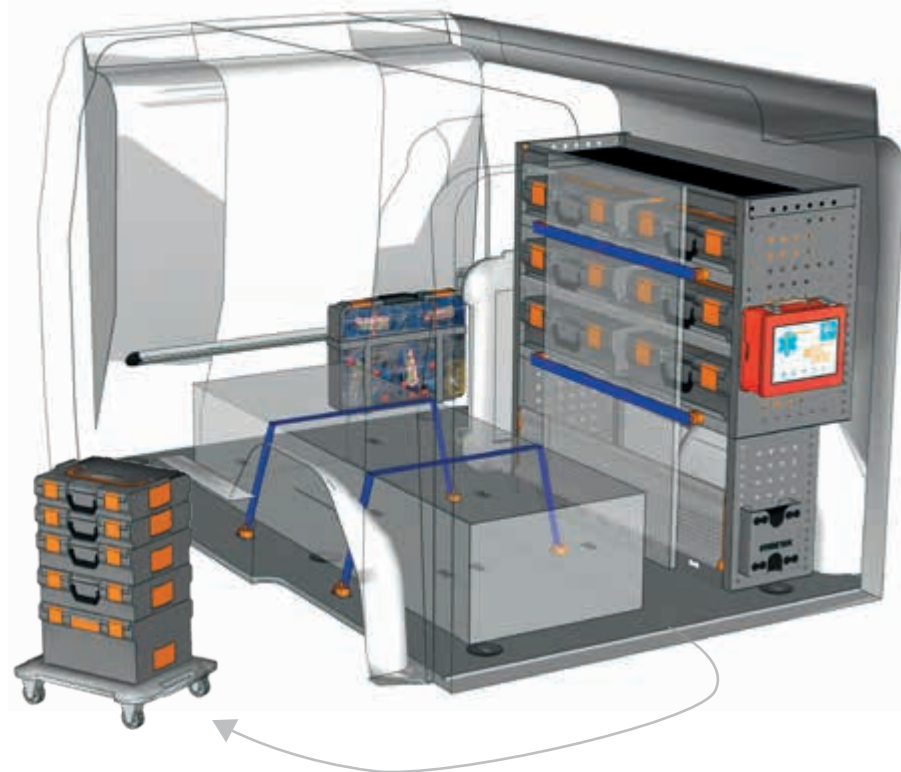

BEISPIEL - EXAMPLE

EXAMPLE DO L2H1 M2*

- | | |
|-------------------------|-------------------------|
| 1 x D0 1010 M2 | 1 x F22 SB CPV080 00 01 |
| 1 x F22 SF D020K1 B0 1S | 2 x F22 FC V22136 00 00 |
| 1 x F22 VT V22585 00 08 | 2 x F22 FC V22124 00 00 |
| 1 x F22 FC V18029 10 00 | 2 x F22 FC V22148 00 00 |
| 2 x F22 FC V22106 00 00 | 1 x F22 SB YELLOW 63 05 |
| 1 x F22 SB BOX080 00 01 | 4 x F22 FC V22582 00 00 |

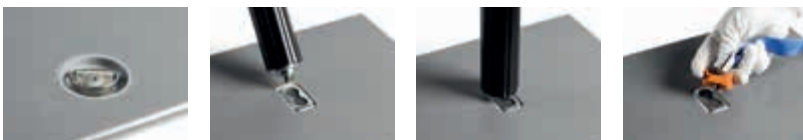

siehe Seiten 10/11
see pages 10/11

* Einschließlich Befestigungskit - Fixing kit included

Haben Sie Ihre Einrichtung nicht gefunden?

Verlassen Sie sich auf die Profis für Fahrzeugeinrichtungen.

Auf der Rückseite dieses Katalogs finden Sie die nächstgelegene StoreVan Niederlassung. Besuchen Sie unsere Web-Seite.

Didn't find the equipment you're looking for?

Leave it to our experts.

See the back of this catalogue and contact the nearest StoreVan point or visit our website.



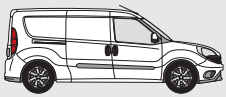

L2 H1

FIAT DOBLÒ
KASTENWAGEN - PANEL VAN

FLOOR UP 250

L2 H1

FLOOR UP BODENPLATTE H 250 mm
FLOORING H 250 mm

FAHRZEUGEINRICHTUNGSBEISPIELE - FITTINGS EXAMPLES

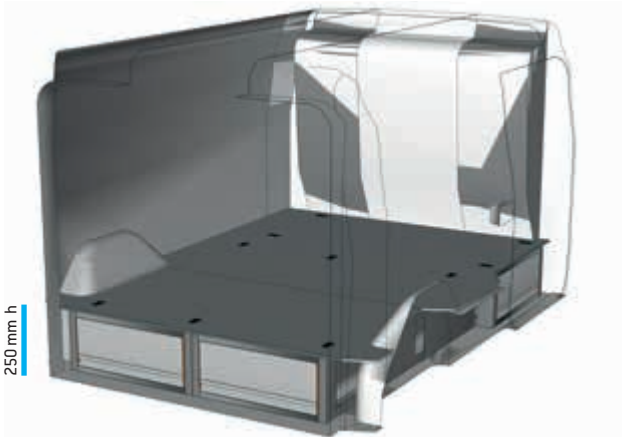

BEISPIEL - EXAMPLE

DO 0250 21*

B=1930 T=1489 H=269 mm - W=1930 D=1489 H=269 mm
(nur für Kabinenrückwand aus Vollblech / only for sheet steel bulkhead)

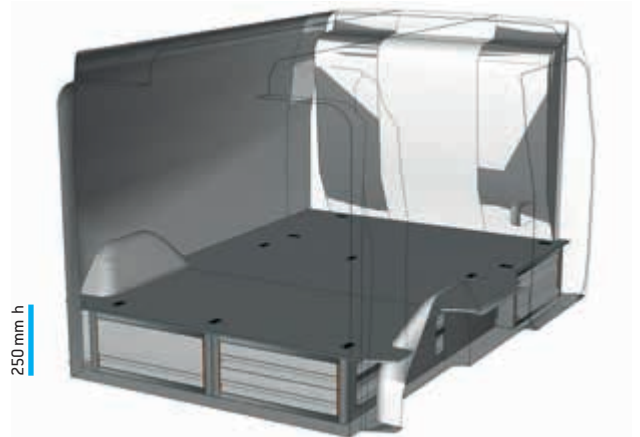

BEISPIEL - EXAMPLE

DO 0250 22*

B=1930 T=1489 H=269 mm - W=1930 D=1489 H=269 mm
(nur für Kabinenrückwand aus Vollblech / only for sheet steel bulkhead)

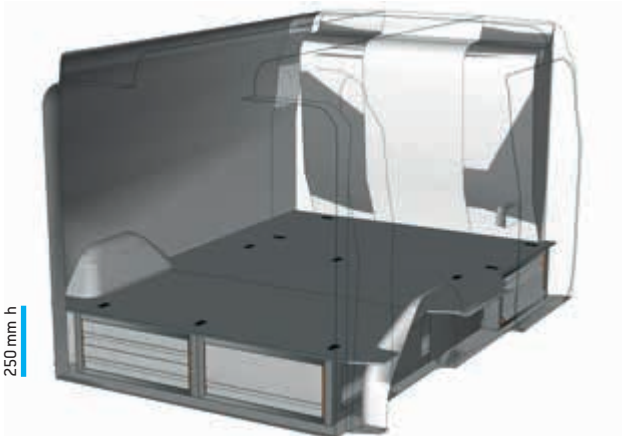

BEISPIEL - EXAMPLE

DO 0250 23*

B=1930 T=1489 H=269 mm - W=1930 D=1489 H=269 mm
(nur für Kabinenrückwand aus Vollblech / only for sheet steel bulkhead)

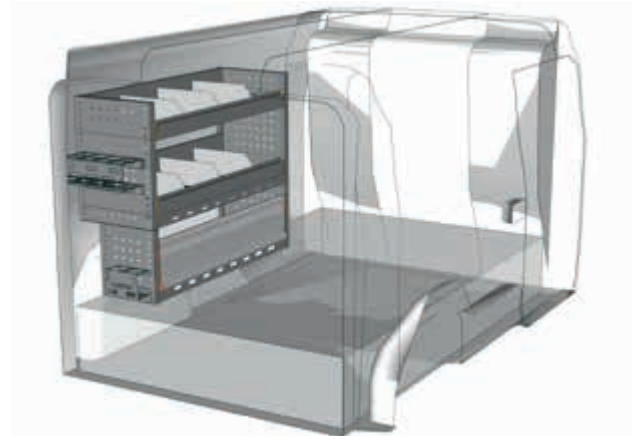

BEISPIEL - EXAMPLE

DO 1008 01*

B=1016 T=365 H=800 mm - W=1016 D=365 H=800 mm

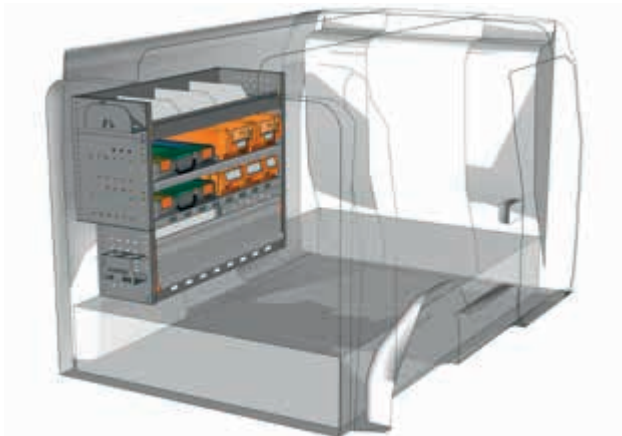
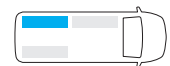

BEISPIEL - EXAMPLE

DO 1008 02*

B=1016 T=365 H=800 mm - W=1016 D=365 H=800 mm

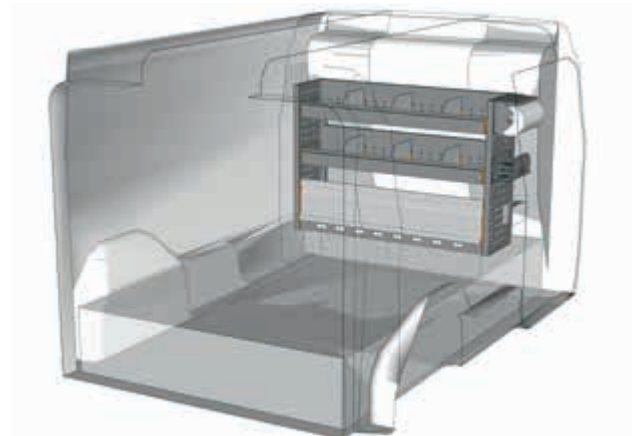

BEISPIEL - EXAMPLE

DO 1007 02*

B=1016 T=265 H=700 mm - W=1016 D=265 H=700 mm



* Einschließlich Befestigungskit - Fixing kit included

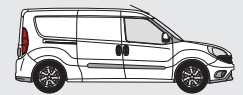

FAHRZEUGEINRICHTUNGSBEISPIELE - FITTINGS EXAMPLES

BODENPLATTE H 250 mm
FLOORING H 250 mm **FLOOR UP**

L2 H1

KASTENWAGEN - PANEL VAN
FIAT DOBLÒ

FLOOR UP 250

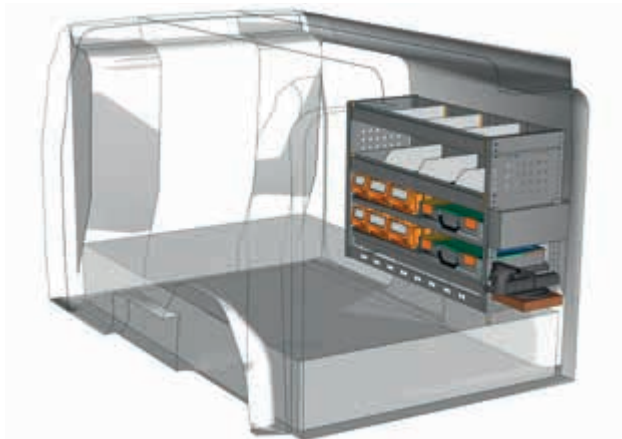

BEISPIEL - EXAMPLE

DO 1007 03*

B=1016 T=365 H=700 mm - W=1016 D=365 H=700 mm

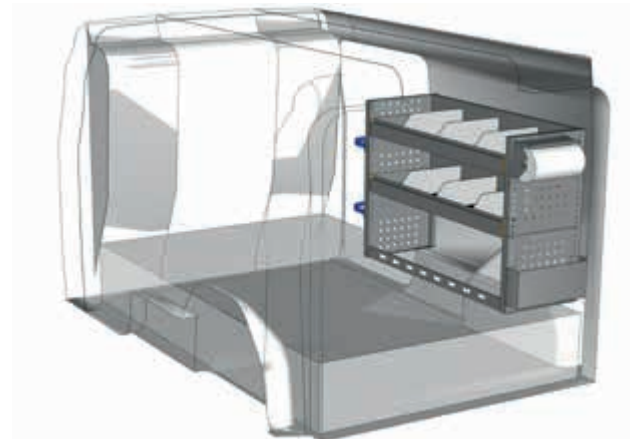

BEISPIEL - EXAMPLE

DO 1007 04*

B=1016 T=365 H=700 mm - W=1016 D=365 H=700 mm

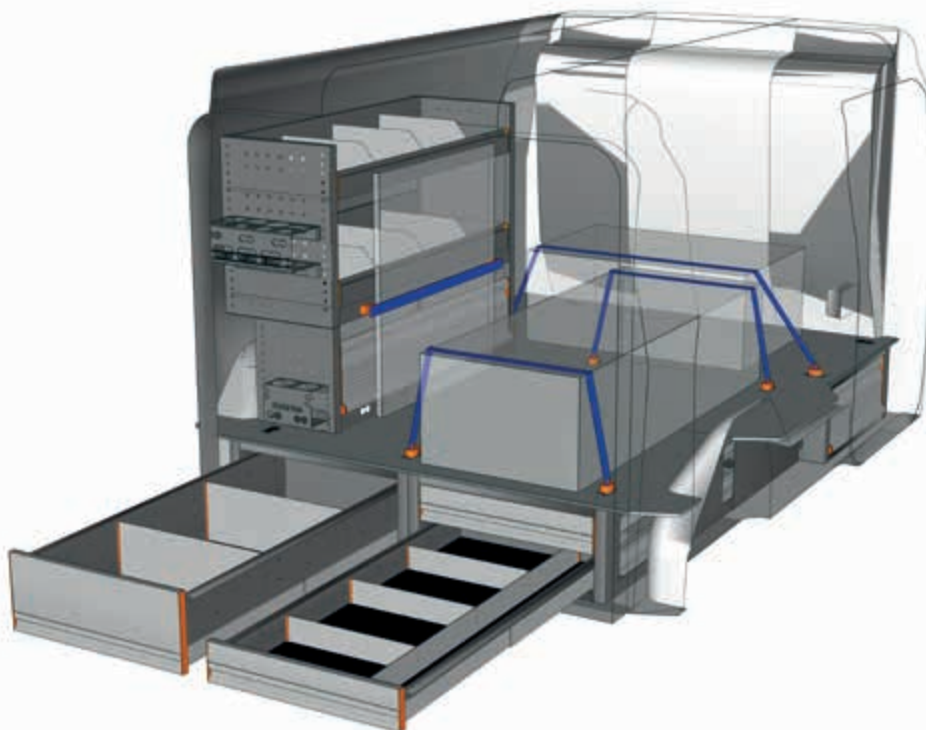
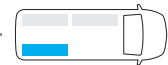

BEISPIEL - EXAMPLE

EXAMPLE DO L2H1 F1*

- 1 x DO 0250 22
- 1 x DO 1008 01
- 1 x E8 093058 H0
- 1 x E8 093058 L0
- 1 x E8 108058 C4
- 4 x F22 FC V22136 00 00



siehe Seiten 10/11
see pages 10/11

* Einschließlich Befestigungskit - Fixing kit included

Haben Sie Ihre Einrichtung nicht gefunden?
Verlassen Sie sich auf die Profis für Fahrzeugeinrichtungen.
Auf der Rückseite dieses Katalogs finden Sie die nächstgelegene StoreVan Niederlassung. Besuchen Sie unsere Web-Seite.

Didn't find the equipment you're looking for?
Leave it to our experts.
See the back of this catalogue and contact the nearest StoreVan point or visit our website.



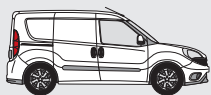

FAHRZEUG VEHICLE	DACHTRAVERSEN ROOF RACK BARS	ABMESSUNGEN DIMENSIONS	GEWICHT WEIGHT	TRAGKRAFT LOAD CAPACITY
	ART.			
Fahrzeugtyp - Model L1 H1	F22 FF D010H1 B1 00	1580x1460 mm	10,00 kg	90,00 kg
Fahrzeugtyp - Model L2 H1	F22 KK D020H1 B1 00	2080x1460 mm	10,00 kg	90,00 kg

- Nur für Fahrzeug mit Heckflügeltüren.
- Only for vehicle with rear leaf doors.



FAHRZEUG VEHICLE	DACHTRÄGER ROOF RACK	ABMESSUNGEN DIMENSIONS	GEWICHT WEIGHT	TRAGKRAFT LOAD CAPACITY
	ART.			
Fahrzeugtyp - Model L1 H1	F22 KK D010H1 R1 00	2000x1500 mm	17,00 kg	83,00 kg
Fahrzeugtyp - Model L2 H1	F22 KK D020H1 R1 00	2500x1500 mm	18,50 kg	81,50 kg

- Nur für Fahrzeug mit Heckflügeltüren.
- Only for vehicle with rear leaf doors.

DACHTRAVERSEN - ROOF RACK BARS

- Dachtraversen bestehend aus:
 - Alu-Querschienen inkl. Befestigungen und Gummiprofilen
 - Schraubmaterial aus Edelstahl
- Roof Rack Bars complete of:
 - aluminium crossbars with fixing parts and rubber profile
 - fixing screws in stainless steel

DACHTRÄGER - ROOF RACK

- Dachträger bestehend aus:
 - Alu-Querschienen inkl. Befestigungen und Gummiprofilen
 - Seitenwänden aus Aluminium
 - Laderolle aus Aluminium
 - Schraubmaterial aus Edelstahl
- Roof Rack complete of:
 - aluminium crossbars with fixing parts and rubber profile
 - aluminium side rails
 - aluminium loading roller
 - fixing screws in stainless steel

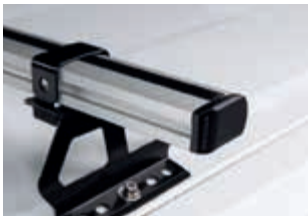
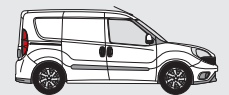

- Kappen paarweise
- Pair of end caps

ART. **F22 UP 070010 00 07**



- Endlaschen light paarweise
- Pair of light end fins

ART. **F22 UP 070040 00 07**
73x100 mm H



- Endlaschen strong paarweise
- Pair of strong end fins

ART. **F22 UP 070050 00 07**
60x53x200 mm H



- Mittellasche rechts light
- Central right-hand fin

ART. **F22 UP 070060 00 07**
133x53x64 mm H



- Mittellasche links light
- Central left-hand fin

ART. **F22 UP 070070 00 07**
133x53x64 mm H



- Anschläge paarweise
- Pair of stops

ART. **F22 UP 070100 00 07**
70x33x90 mm H



- Klappbarer Anschlag light
- Light collapsible stop

ART. **F22 UP 070080 00 ZZ**



- Klappbarer Anschlag strong
- Strong collapsible stop

ART. **F22 UP 070090 00 ZZ**



- Set Halterung für Blinklicht*
- Warning light support kit*

ART. **F22 UP 070170 00 07**
200x161 mm



- Set Befestigung für Rolle
- Roll fixing kit

ART. **F22 UP 070180 00 ZZ**



- Selbstsperrender Riemen
- Self-locking strap

ART. **F22 CMV 23575 00 00**
1000x25 mm H
F22 CMV 97020 00 00
1200x35 mm H



- Rohrträger aus Edelstahl
- Stainless steel tube carrier

ART. **F22 PA 07A211 00 ZZ**
2110 mm - Ø 160 mm
F22 PA 07A324 00 ZZ
3240 mm - Ø 160 mm

* Ohne Blinklicht
* Warning light not included



- Rohrträger aus stabilisiertem PVC
- Stabilised PVC tube carrier

ART. **F22 UP 070200 00 2V**
2115 mm - Ø 160 mm
F22 UP 070210 00 2V
2115 mm - Ø 200 mm
F22 UP 070220 00 2V
3050 mm - Ø 160 mm
F22 UP 070230 00 2V
3050 mm - Ø 200 mm



- Verstärkung für Traverse
- Bar reinforcement

ART. **F22 UP 070110 00 ZZ**
1160 mm
F22 UP 070120 00 ZZ
1360 mm
F22 UP 070130 00 ZZ
1460 mm
F22 UP 070140 00 ZZ
1560 mm
F22 UP 070150 00 ZZ
1660 mm
F22 UP 070160 00 ZZ
1760 mm

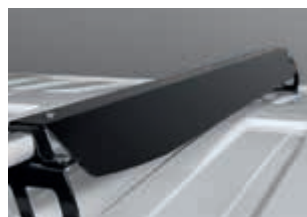

- Spoiler
- Spoiler

ART. **F22 UP 050850 00 07**
850 mm
F22 UP 050950 00 07
950 mm
F22 UP 051100 00 07
1100 mm

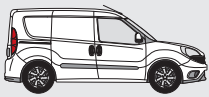

FAHRZEUG VEHICLE	LEITERTRÄGER LADDER RACK	ABMESSUNGEN DIMENSIONS	GEWICHT WEIGHT	TRAGKRAFT LOAD CAPACITY
	ART.			
Fahrzeugtyp - Model L1 H1	F22 KK D010H1 L1 00	2150x1480 mm	48,50 kg	51,50 kg
Fahrzeugtyp - Model L2 H1	F22 KK D020H1 L1 00	2650x1480 mm	53,00 kg	47,00 kg

- Nur für Fahrzeug mit Heckflügeltüren. Der Leiterträger kann links oder rechts montiert werden.
- Only for vehicle with rear leaf doors. The ladder rack rail can be mounted on the right or left side.



FAHRZEUG VEHICLE	DYNAMISCHER DACHTRÄGER DYNAMIC ROOF RACK	ABMESSUNGEN DIMENSIONS	GEWICHT WEIGHT	TRAGKRAFT LOAD CAPACITY
	BEISPIEL - EXAMPLE			
Fahrzeugtyp - Model L1 H1	DO 10H1 D1	2250x1218 mm	69,00 kg	31,00 kg
Fahrzeugtyp - Model L2 H1	DO 20H1 D1	2550x1218 mm	71,00 kg	29,00 kg

- Nur für Fahrzeug mit Heckflügeltüren.
- Only for vehicle with rear leaf doors.

LEITERTRÄGER - LADDER RACK

- Leiterträger bestehend aus:
 - Alu-Querschienen inkl. Befestigungen und Gummiprofilen
 - Seitenwand aus Aluminium
 - Laderolle aus Aluminium
 - Leiterschiene aus Aluminium und Edelstahl
 - Schraubmaterial aus Edelstahl
- Ladder Rack complete of:
 - aluminium crossbars with fixing parts and rubber profile
 - aluminium side rail
 - aluminium loading roller
 - ladder rack rail made of aluminium and stainless steel
 - fixing screws in stainless steel

DYNAMISCHER DACHTRÄGER - DYNAMIC ROOF RACK

- Dynamischer Dachträger bestehend aus:
 - Fester Aluminiumrahmen mit Dachträger-Befestigungen
 - Gleitender Schlittenrahmen mit Querstreben und Seitenwänden
 - Schraubmaterial aus Edelstahl
- Dynamic Roof Rack complete of:
 - fixed aluminium frame with couplers
 - sliding frame with bars and lateral panels
 - fixing screws in stainless steel



Der Montage ist nicht inkludiert
Assembly is not included

** Anpassbar für Seitenwände in jeder Länge
** Adaptable to any side barrier length



- Set Funkfernsteuerung max. 10 A und Fernbedienung für LED-Leuchte
- MAX 10 A radio remote control kit and remote control for LED light

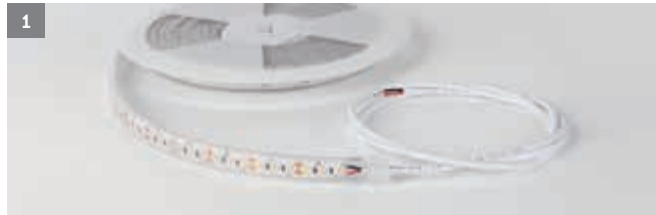

- LED-Leuchtstreifen mit doppeltem Kabel
- LED strip with double cable



- Opales Streuprofil aus Polycarbonat für LED-Leuchte
- Opal polycarbonate diffuser profile for LED light

ART. **F22 UP 070510 00 00**

- Set Funkfernsteuerung max. 24 A und Fernbedienung für LED-Leuchte
- MAX 24 A radio remote control kit and remote control for LED light

ART. **F22 UP 070530 00 10**
Oranges Licht
Orange light
4100 mm**

ART. **F22 UP 070530 00 13**
Weißes Licht
White light
4100 mm**

ART. **F22 UP 070540 00 13**
Weißes Licht
White light
3400 mm**

ART. **F22 UP 070550 00 13**
Weißes Licht
White light
2750 mm**

ART. **F22 UP 070560 00 13**
Weißes Licht
White light
2000 mm**

ART. **F22 UP 070410 00 00**
3000 mm**

ART. **F22 UP 070420 00 00**
4700 mm**

ART. **F22 UP 070520 00 00**



- Fester Rundhaltebügel Leiter
- Ladder locking fixed arch

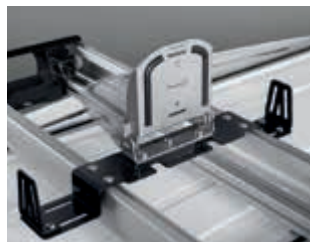

- Klappbarer Rundhaltebügel Leiter
- Ladder locking collapsible arch

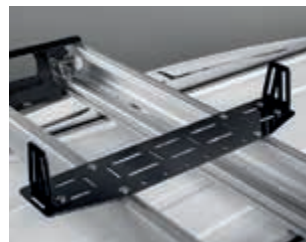

- Universal-Befestigungsplatte
- Universal fixing plate



- Verlängerung
- Extension

ART. **F22 UP 070300 00 07**

ART. **F22 UP 070310 00 07**

ART. **F22 UP 070320 00 07**

ART. **F22 UP 070330 00 07**



- Set Gasfedern
- Gas spring kit

ART. **F22 UP 070340 00 00**
30 daN

ART. **F22 UP 070350 00 00**
70 daN

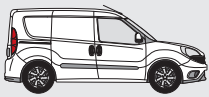

ART. **F22 KT PAP265 00 01**

- Papierrollenhalter mit Papierrolle Ø 130 mm
- Paper towel holder kit with paper towel Ø 130 mm



ART. **F22 KT CAB220 00 01**

- Schlauchhalter
- Cable saddle



ART. **F22 KT SPR365 00 01**

- Spraydosenshalter T=365 mm
- Spray-can holder kit D=365 mm



ART. **F22 KT PAP365 00 01**

- Papierrollenhalter mit Papierrolle Ø 240 mm
- Paper towel holder kit with paper towel Ø 240 mm



ART. **F22 KT CAB296 00 01**

- Schlauchhalter-Satz
- Cable saddle-kit



ART. **F22 KT SIL296 00 01**

- Kartuschen - Spraydosenshalter
- Kit silicone - spray cans holder



ART. **F22 KT AID265 00 01**

- Verbandkasten
- First aid kit



ART. **F22 KT DOC365 00 00**

- Plantasche A4 - 362x68x209 mm H
- A4 documents holder - 362x68x209 mm H



ART. **F22 KT SPR160 00 01**

- Satz 2-Stellen Spraydosenshalter
- Spray-can holder kit [2 slots]



ART. **F22 KT WAS000 00 00**

- Behälter mit Feuchttüchern
- Workshop wipes tub



ART. **F22 KT REC365 00 01**

- Set Haltebügel für Behälter
- Workshop wipes holder kit



ART. **F22 KT WAS365 00 01**

- Handwasch Kit
- Hand wash kit

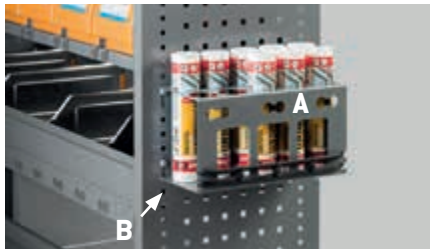

Kartuschenhalter
Kit silicone holder

A + B

ART. **F22 KT BAR296 00 01** A

- Träger für Silikon-Kartuschen- / Gewindestangenhalter
- Support for silicone cartridges / threaded-bar holder

ART. **F22 KT BAR296 02 01** B

- Adapter für Silikon-Kartuschen
- Adapter for silicone cartridges

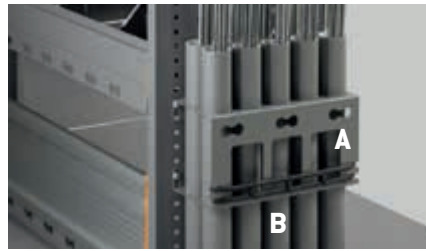

Gewindestangenhalter-Satz
Threaded-bar holder kit

A + B

ART. **F22 KT BAR296 00 01** A

- Träger für Silikon-Kartuschen- / Gewindestangenhalter
- Support for silicone cartridges / threaded-bar holder

ART. **F22 KT BAR296 01 01** B

- 5 Rohren für Gewindestangenhalter
- 5 Pipe for threaded-bar holder

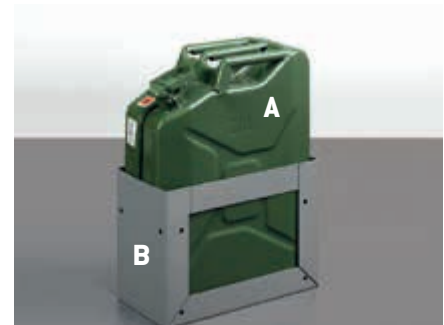

ART. **F22 KT OIL20L 00 00** A

- Stahlkanister inhalt 20 LT
- Metal can capacity 20 LT

ART. **F22 KT OIL365 00 01** B

- Kanisterhalter
- Can holder



ART. **F22 FA BL7433 00 01** A

- Behälterschiene für 1 Behälter gröÙe 1PL
- Container rail for 1 container size 1PL

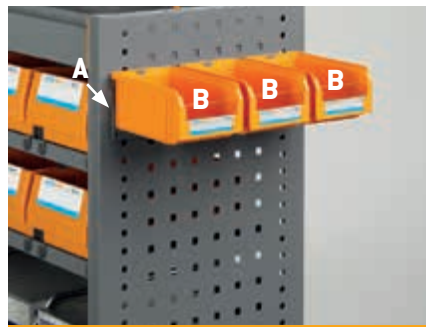

ART. **F22 FA BL7434 00 01** A

- Behälterschiene für 3 Behältern gröÙe 1PL
- Container rail for 3 containers size 1PL

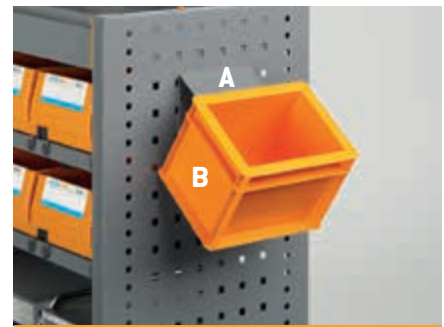

ART. **F22 FA BL7432 00 01** A

- Behälterschiene für 1 Behälter Euro Box
- Container rail for 1 container Euro Box

ART. **F22 FA PM1751 00 25** B

- Kunststoffbehälter gröÙe 1PL
- Polypropylene container size 1PL

ART. **F22 FA PM1751 00 25** B

- Kunststoffbehälter gröÙe 1PL
- Polypropylene container size 1PL

ART. **F22 FA PA2251 A0 25** B

- Kunststoffkasten aus Polypropilen serie Euro Box
- Polypropylene boxes series Euro Box



ART. **F22 KT MAG020 00 00**

- Magnetensatz 10 Stk Ø 20 mm
- Set of 10 magnets Ø 20 mm



ART. **F22 KT RUB160 00 01**

- Halter für Ladungssicherungspads
158x50x171 mm H
- Non-slip mats holder - 158x50x171 mm H

ART. **F22 KT MAG025 00 00**

- Magnetensatz 10 Stk Ø 25 mm
- Set of 10 magnets Ø 25 mm

ART. **F22 KT RUB000 00 07**

- Satz 6 Ladungssicherungspads - 150x150x3 mm H
- 6 non-slip mats kit - 150x150x3 mm H



ANWENDUNGSBEISPIEL FÜR SATZ LADUNGSSICHERUNGSPADS

Die Antirutschmatten ermöglichen den Reibungswert bis zu μ_D 0.6 nach DIN EN 12195-1: 2004 und VDI 2700 ff zu erhöhen. Das Messverfahren befolgt die Richtlinie „VDI 2700 - 15“.

USE CASE FOR NON-SLIP MAT

Non-slip mats are used to increase the coefficient of friction up to μ_D 0.6 following the calculus DIN EN 12195-1: 2004 and VDI 2700 ff. The measuring procedure should follow the directive "VDI 2700 - 15"

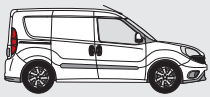

ART. **F22 KT VAL365 00 01**

- Set Halter für Koffer Box 080
- Box 080 tool case holder kit



ART. **F22 KT ORG000 00 39**

- Beifahrersitz-Organizer
- Passenger seat organizer



ART. **F22 WW MOBILE 10 00**

- Klapptisch Work Wood - 980x423x802 mm H
- Table with folding legs - 980x423x802 mm H



ART. **F22 KT DIS000 00 01**

- Umkehrbarer Spenderhalter
- Reversible dispenser holder



ART. **F22 KT GLV000 00 01**

- Einweghandschuhspender
- Disposable glove dispenser



ART. **F22 KT LED001 00 00**

- Led Lampe IP20 12V B=600 mm
- Led lamp IP20 12V W=600 mm

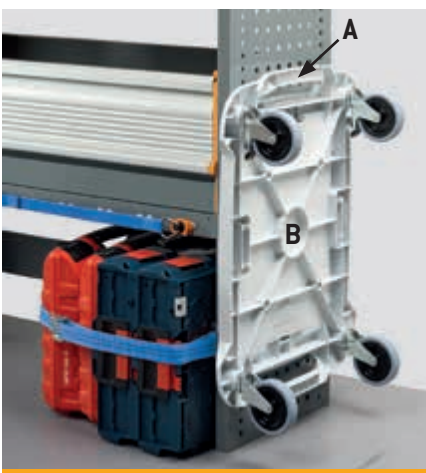

ART. **F22 SB OOROLL SU 01** **A**

- Schienenträgern-Satz für STORE BOX ROLL
- Set of supports for STORE BOX ROLL

ART. **F22 SB OOROLL 00 08** **B**

- Plattform mit Rollen mit Bremsen für Koffer BOX 102-136-238-374
- Trolley with castors with brakes for tool case BOX 102-136-238-374



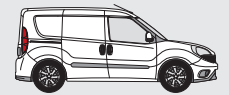

ART. **F22 KT FIR000 00 01** A

- Gasflaschenhalter
- Gas cylinder kit



ART. **F22 FC V18029 03 00** A

- Horizontale Lasthalteschiene mit medium Lochung B=365 mm
- Horizontal load restraining bar with medium hole connector W=365 mm

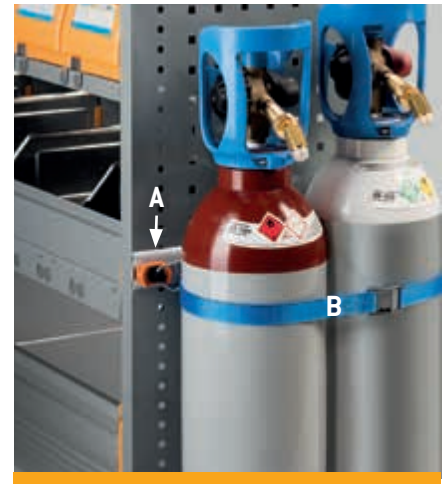

ART. **F22 FC V18029 03 00** A

- Horizontale Lasthalteschiene mit medium Lochung B=365 mm
- Horizontal load restraining bar with medium hole connector W=365 mm

ART. **F22 KT FIR4KG 00 00** B

- Feuerloescher (Pulver) 4 KG
- Fire extinguisher (powder) 4 KG

ART. **F22 FC V18029 04 00** A

- Horizontale Lasthalteschiene mit medium Lochung B=445 mm
- Horizontal load restraining bar with medium hole connector W=445 mm

ART. **F22 FC V18029 04 00** A

- Horizontale Lasthalteschiene mit medium Lochung B=445 mm
- Horizontal load restraining bar with medium hole connector W=445 mm

ART. **F22 FC V22868 00 00** B

- Zurrgurte mit Ratschenschloss mit medium Anschlussteil
- Medium connector ratchet load restraining belt

ART. **F22 FC V22869 00 00** B

- Zurrgurte mit Hebelspannschloss mit medium Anschlusssteil
- Medium connector clamp load restraining belt

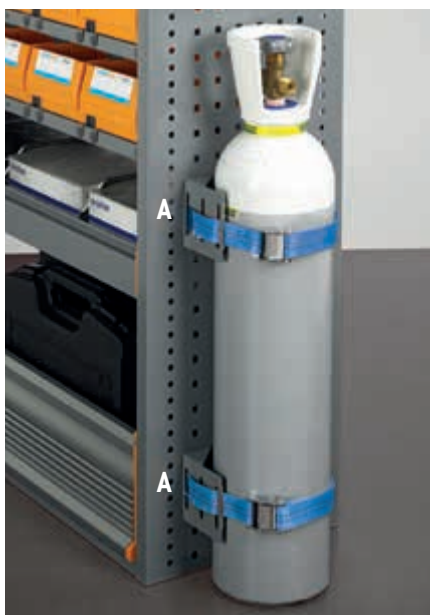

Beispiel mit
2 ART. **F22 KT FIR000 00 01**
Example with
2 ART. **F22 KT FIR000 00 01**

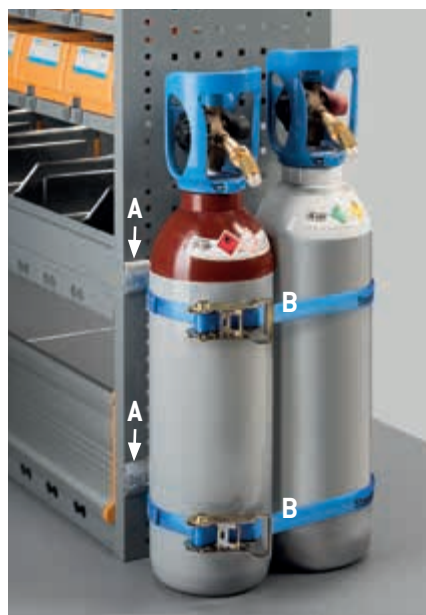

Beispiel mit
2 ART. **F22 FC V18029 03 00**
2 ART. **F22 FC V22868 00 00**
Example with
2 ART. **F22 FC V18029 03 00**
2 ART. **F22 FC V22868 00 00**

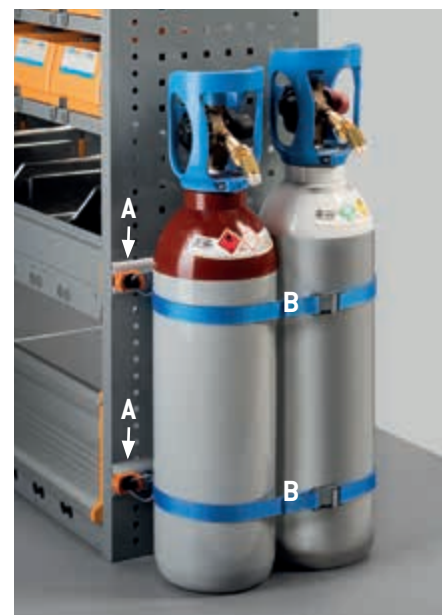

Beispiel mit
2 ART. **F22 FC V18029 03 00**
2 ART. **F22 FC V22869 00 00**
Example with
2 ART. **F22 FC V18029 03 00**
2 ART. **F22 FC V22869 00 00**





KASTENWAGEN - PANEL VAN
FIAT DOBLÒ

FIAT DOBLÒ

LIEFERBEDINGUNGEN

- Bodenplatten und Seitenverkleidungen werden in mehreren Teilen geliefert.
- Dachträger und Leiterträger werden **lose** geliefert.
- Module werden **vormontiert** komplett mit Fahrzeugbefestigungsmaterial geliefert.
- Produkte sollen vorzugsweise von **Vertragshändlern** installiert werden.
- Produkte werden **verpackt** geliefert.
- **5 Jahre Garantie** auf unsere Komponenten.
- Die Tragkräfte beziehen sich auf **gleichmäßig verteilte Last**.



SUPPLY CONDITIONS

- Flooring and linings supplied in several pieces.
- Roof and ladder racks supplied **flat-packed**.
- Modules are supplied **preassembled** complete of fixing material to the vehicle.
- For products installation, please get in touch with our **approved installer's network**.
- Products provided **with packaging**.
- Our products are covered by a **5-years warranty**.
- Load capacities refer to **uniformly distributed loads**.



FAMI S.R.L.

VIA STAZIONE ROSSANO, 13 – 36027 ROSÀ (VI) ITALY
TEL +39 0424 585455 R.A. – FAX +39 0424 585482
INFO@FAMISPA.COM – WWW.FAMISPA.COM

INFO@STOREVAN.COM – WWW.STOREVAN.COM

